



ARCTIC ESSENTIALS

**OWNERS MANUAL**



<b>Safety Information / Warnings</b>	<b>2-4</b>
<b>Introduction</b>	<b>5</b>
<b>Overview</b>	<b>6</b>
<b>Keypad Installation</b>	<b>7-8</b>
<b>Electrical Wiring</b>	<b>9</b>
<b>Heater Connections</b>	<b>10</b>
<b>Power-up &amp; breaker setting</b>	<b>11-12</b>
<b>Keypad Overview</b>	<b>13-16</b>
<b>Error Codes</b>	<b>16-21</b>
<b>Troubleshooting</b>	<b>22-32</b>
<b>Water Maintenance</b>	<b>33-37</b>
<b>Specifications</b>	<b>38-40</b>
<b>Warranty</b>	<b>40-41</b>

# Important Safety Instructions:

## READ AND FOLLOW ALL INSTRUCTIONS CAREFULLY

When installing and using this electrical equipment, basic safety precautions should always be followed, including:

- 1) **WARNING:** To reduce the risk of injury, do not permit children to use this product unless they are closely supervised at all times.
- 2) **WARNING:** A grounding wire connector is provided on this unit to connect a minimum No. 8 AWG solid copper conductor (USA) No. 6 AWG stranded (Canada) 8.4mm (Europe) between this unit and any metal equipment, metal enclosures of electrical equipment, metal water pipe, or conduit within 5 feet (1.5 m) of the unit.
- 3) **DANGER:** Risk of Accidental Drowning. Extreme caution must be exercised to prevent unauthorized access by children. To avoid accidents, ensure that children cannot use this hot tub unless they are supervised at all times. Use the hot tub straps, cover safety and clip tie downs to secure the cover when not in use. This will help to discourage unsupervised children from entering the hot tub. There is no representation that the cover, clip tie downs, or actual locks will prevent access to the hot tub.
- 4) **DANGER:** Risk of Injury. The suction fittings in this hot tub are sized to match the specific water flow created by the pump. Should the need arise to replace the suction fittings or the pump, be sure that the flow rates are compatible. Never operate the hot tub if the suction fittings are broken or missing. Consult your local dealer for assistance in choosing an appropriate replacement suction fitting.

5) **DANGER:** Risk of Electric Shock. Install at least 5 feet (1.5 m), from all metal surfaces. As an alternative, a hot tub may be installed within 5 feet (1.5 m) of metal surfaces if each metal surface is permanently connected (bonded) by a minimum No. 8 AWG solid copper conductor (US) No. 6 AWG stranded (Canada) 8.4 mm (Europe) attached to the wire connector on the equipotential bonding bar which is located on the side of the spa control pack.

6) **DANGER:** Risk of Electric Shock. Do not permit any electrical appliance, such as a light, telephone, radio, television, etc. within 5 feet (1.5 m) of a hot tub. All controls or devices accessible from the spa must be powered by a maximum of 12vdc. Do not permit any electrical appliances powered by 12 vdc or more within 1.5 m of the hot tub.

7) **ELECTRICAL SUPPLY:** The electrical supply for this product must include a suitable circuit breaker GFCI (north America) RCD (Europe) to open all ungrounded supply conductors. The disconnect must be readily accessible and visible to the hot tub occupant but installed at least 5 feet (1.5 m), from the hot tub water.

8) **WARNING:** To Reduce the Risk of Injury:

a) The water in a hot tub should never exceed 104°F (40°C). Water temperatures between 100°F (38°C) and 104°F (40°C) are considered safe for a healthy adult. Lower water temperatures are recommended for young children and when hot tub use exceeds 10 minutes.



### IMPORTANT!

This manual was written to ensure the proper use and installation of any Arctic Spa. Any modifications to the procedures outlined may result in your warranty being voided. Please read this manual to avoid any unnecessary damage to your spa and equipment.

- b) Since excessive water temperatures have a high potential for causing fetal damage during the early months of pregnancy, pregnant or possibly pregnant women should limit hot tub water temperatures to 100°F (38°C). If pregnant, please consult your physician before using a hot tub.
- c) The use of alcohol, drugs, or medication before or during hot tub use may lead to unconsciousness with the possibility of drowning.
- d) Persons suffering from obesity or a medical history of heart disease, low or high blood pressure, circulatory system problems, or diabetes should consult a physician before using a hot tub.
- e) Persons using medication should consult a physician before using a hot tub since some medication may induce drowsiness, while other medication may affect heart rate, blood pressure, and circulation.
- 9) A bonding lug bar is provided on the side of your spa pack to accommodate grounding of entire spa. To reduce the risk of electric shock, connect the local common bonding grid in the area of the hot tub to these terminals with an insulated or bare copper conductor not smaller than No. 8 AWG solid (US) No. 6 AWG stranded (Canada) 8.4 mm (Europe).

## SAVE THESE INSTRUCTIONS

### WARNINGS!

**WARNING:** Children should not use hot tubs without adult supervision.

**AVERTISSEMENT:** Ne pas laisser les enfants utiliser une cuve de relaxation sans surveillance.

**WARNING:** Do not use hot tubs unless all suction guards are installed to prevent body and hair entrapment.

**AVERTISSEMENT:** Pour éviter que les cheveux ou une partie du corps puissent être aspirés, ne pas utiliser une cuve de relaxation si des grilles de prise d'aspiration ne sont pas toutes en place.

**WARNING:** People with infectious diseases should not use a hot tub.

**AVERTISSEMENT:** Les personnes atteintes de maladies infectieuses ne devraient pas utiliser une cuve de relaxation.

**WARNING:** To avoid injury, exercise care when entering or exiting the hot tub.

**AVERTISSEMENT:** Pour éviter des blessures, user de prudence en entrant dans une cuve de relaxation et en sortant.

**WARNING:** Do not use drugs or alcohol before or during the use of a hot tub to avoid unconsciousness and possible drowning.

**AVERTISSEMENT:** Pour éviter l'évanouissement et la noyade éventuelle, ne prendre ni drogue ni alcool avant d'utiliser une cuve de relaxation ni quand on s'y trouve.

**WARNING:** Pregnant or possibly pregnant women should consult a physician before using a hot tub.

**AVERTISSEMENT:** Les femmes enceintes, que leur grossesse soit confirmée ou non, devraient consulter un médecin avant d'utiliser la cuve de relaxation.

**WARNING:** Water temperature in excess of 100°F (38°C) may be injurious to your health.

**AVERTISSEMENT:** Il peut être dangereux pour la santé de se plonger dans de l'eau à plus de 100°F (38°C).

**WARNING:** Before entering the hot tub, measure the water temperature with an accurate thermometer.

**AVERTISSEMENT:** Avant d'utiliser une cuve de relaxation mesurer la température de l'eau à l'aide d'un thermomètre précis.

**WARNING:** Do not use a hot tub immediately following strenuous exercise.

**AVERTISSEMENT:** Ne pas utiliser une cuve de relaxation immédiatement après un exercice fatigant.

**WARNING:** Prolonged immersion in a hot tub may be injurious to your health.

**AVERTISSEMENT:** L'utilisation prolongée d'une cuve de relaxation peut être dangereuse pour la santé.

**WARNING:** Do not permit electric appliances (such as light, telephone, radio, television, etc.) within 5 feet (1.5m) of this hot tub.

**AVERTISSEMENT:** Ne pas placer d'appareil électrique (luminaire, téléphone, radio, téléviseur, etc.) à moins de 5 feet (1.5m) de cette cuve de relaxation.

**CAUTION:** Maintain water chemistry in accordance with manufacturer's instructions.

**ATTENTION:** La teneur de l'eau en matières dissoutes doit être conforme aux directives du fabricant.

**WARNING:** The use of alcohol or drugs can greatly increase the risk of fatal hyperthermia in hot tubs.

**AVERTISSEMENT:** La consommation d'alcool ou de drogue augmente considérablement les risques d'hyperthermie mortelle dans une cuve de relaxation.

**WARNING:** People using medications and / or having an adverse medical history should consult a physician before using a spa or hot tub.

**AVERTISSEMENT:** Les personnes qui prennent des médicaments ou ont des problèmes de santé devraient consulter un médecin avant d'utiliser une cuve de relaxation.

# Hyperthermia

Prolonged immersion in hot water may induce hyperthermia.

Hyperthermia occurs when the internal temperature of the body reaches a level several degrees above the normal body temperature of 99°F (37°C). The symptoms of hyperthermia include drowsiness, lethargy, and an increase in the internal temperature of the body. The effects of hyperthermia include:

- ▶ Unawareness of impending hazard;
- ▶ Failure to perceive heat;
- ▶ Failure to recognize the need to exit hot tub;
- ▶ Physical inability to exit hot tub;
- ▶ Fetal damage in pregnant women; and
- ▶ Unconsciousness and danger of drowning.



## **WARNING!**

The use of alcohol or drugs can greatly increase the risk of fatal hyperthermia in hot tubs or spas.

## Introduction



# Y Series

whatever the spa,  
this is your control system

The Y Series offers the kind of simplicity that makes for a genuine top-of-its-class product. It is the natural choice for anyone who wants an easy-to-understand multi-application solution.

You don't have to wonder about compatibility; instead, there's just the comforting certainty that when you invest in the Y Series, all spa configurations are supported. What's more, it also takes into account future compatibility, so you can have peace of mind knowing that you can enjoy your spa pack for years to come.

## in.ye overview

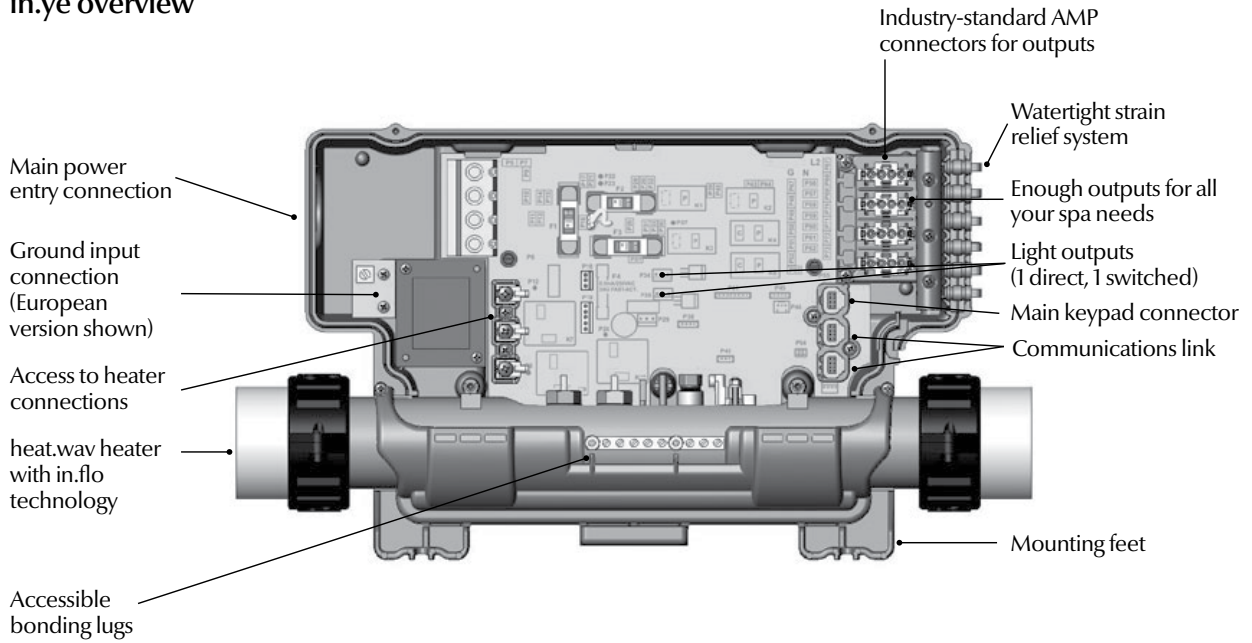

## in.ye dimensions

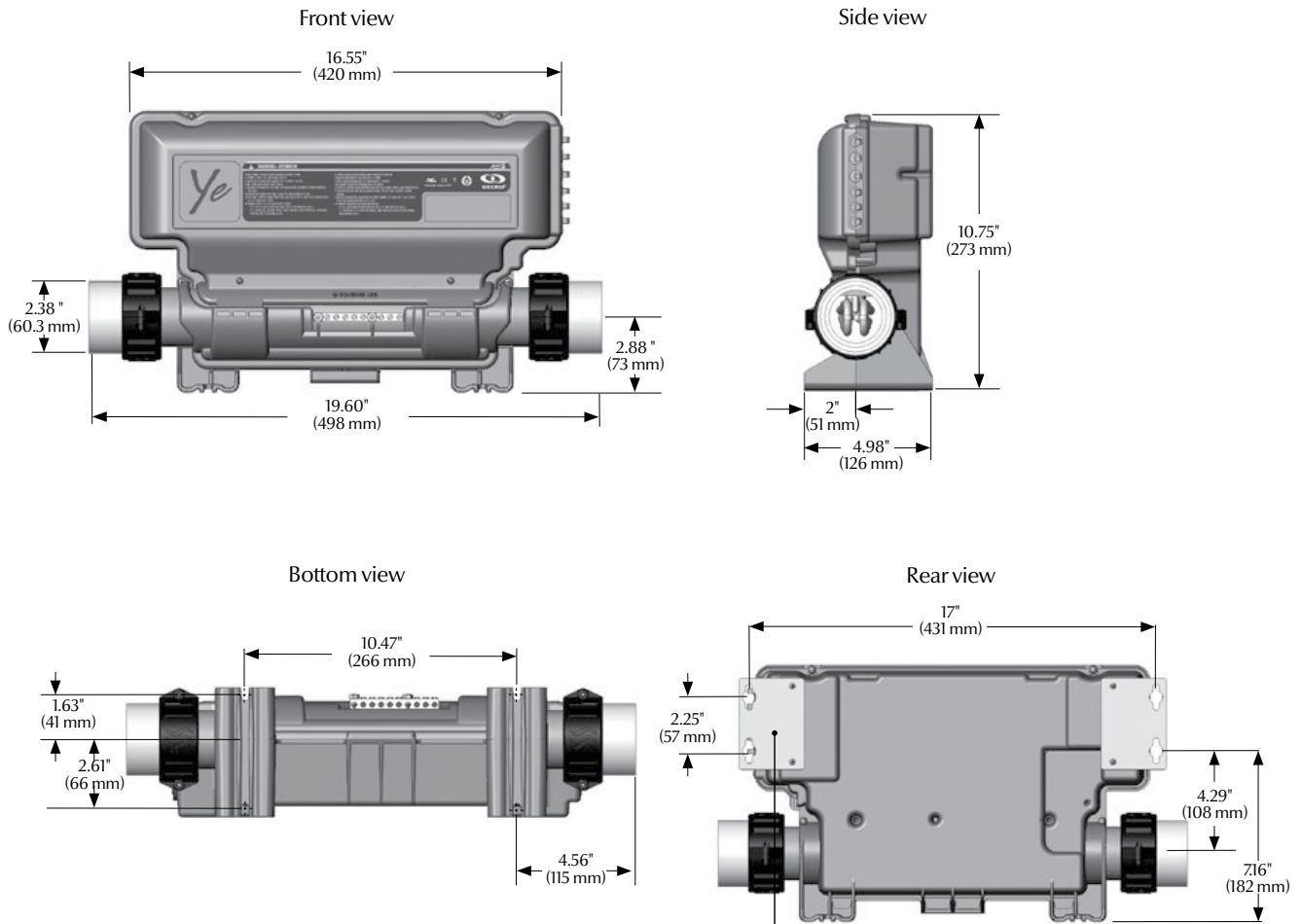

Note: Shown with optional wall mounting brackets (see Installation).

## Keypad installation

See the techbook for your specific keypad model for installation details and drilling template.

### Connecting the main keypad to the spa pack

To connect the keypad, remove the cover, then insert the in.link connector into the appropriate keypad connector (as illustrated). Route the cable through one of the molded strain relief channels on the bottom right side of the spa pack (as illustrated). Fill the remaining space with the foam gaskets supplied. Don't forget to replace the cover and all screws (torque to 8 in.lb max [0.9 N.m]).

*Note: always shut power down before connecting an accessory to the in.ye or in.yt.*

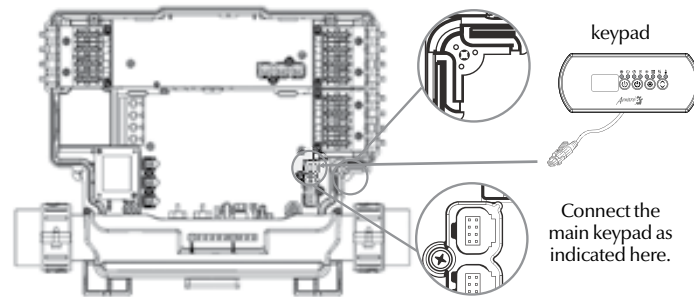



## Y Series connections

### Electrical wiring for North American models

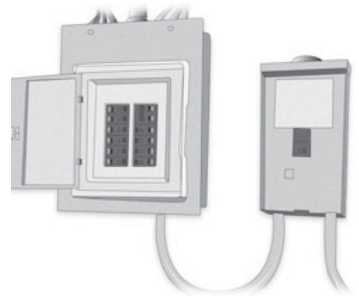

Main electrical box      GFCI panel

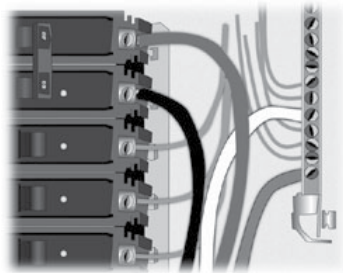

#### **Warning!**

For units for use in other than single-family dwellings, a clearly labeled emergency switch shall be provided as part of the installation. The switch shall be readily accessible to the occupants and shall be installed at least 5' (1.52 m) away, adjacent to, and within sight of the unit.

-----  
This product must always be connected to a circuit protected by a ground fault interrupter.

Proper wiring of the electrical service box, GFCI and in,yt terminal block is essential!

Check your electrical code for local regulations. Only copper wire should be used, never aluminum.

#### **Disposal of the product**

 The appliance (or the product) must be disposed of separately in accordance with the local waste disposal legislation in force.

### Electrical wiring for all models

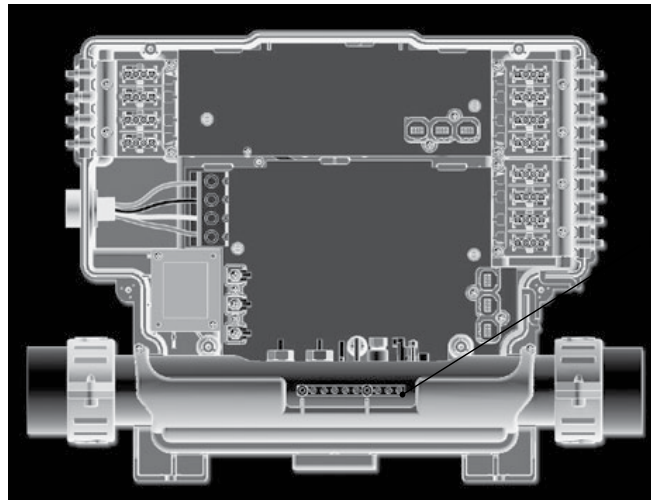

bonding lug

To install the wiring for the Y Series spa control, you'll need a Phillips screwdriver and a flat screwdriver.

Loosen the screws of the spa pack cover and remove it. Remove 5 1/2" (142 mm) of cable insulation. Strip away 1" (25 mm) of each wire insulation. Pull the cable through the cutout of the box and secure it with a strain relief (1" NPT strain relief; hole diameter: 1.335" [33.9 mm]).

(For CE use an IEC certified plastic bushing that will maintain the IPX5 rating.)

Make sure that only the uncut sheathing is clamped at this opening. Make sure that the terminal block case

clamps are lowered before inserting wires.

Push the color-coded wires into the terminals as indicated on the sticker and use the flat screwdriver to tighten the screws on the terminals.

After making sure wire connections are secure, push them back into the box and replace the cover. Tighten the screws of the spa pack cover. Do not over tighten cover screws (torque to 8in.lb max [0.9 N.m]).

Connect the bonding conductor to the bonding lug on the front of the Y Series spa pack (a grounded electrode conductor shall be used to connect the equipment grounding conductors).

### Electrical wiring: North American model

Refer to wiring diagram in the enclosure box lid for more information.

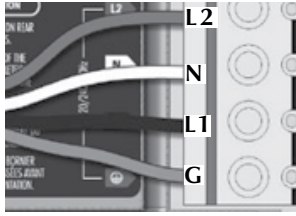

For 240 V (4 wires)

Correct wiring of the electrical service box, GFCI, and pack terminal block is essential.

Call an electrician if necessary.

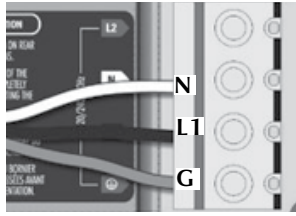

For 120 V (\*3 wires)

\*If connected to a 3 wire system, no 240 V component will work.

*Note:* To convert model to a 120 V system, the white (common) accessory wire must be moved. See wiring diagram for details.

### Electrical wiring: in.ye European model

Refer to wiring diagram in the enclosure box lid for more information.

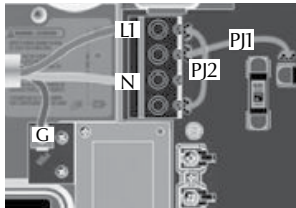

1-phase

Connect P11 between P7 and P13. Connect P2 between P10 and P74.

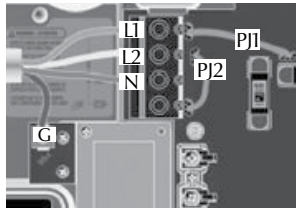

2-phase with single neutral

Connect P11 between P7 and P10. Connect P2 between P13 and P74.

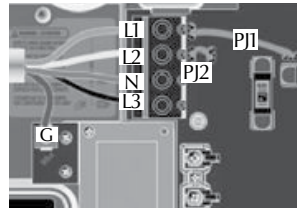

3-phase with single neutral

Connect P11 between P7 and P10. Connect P2 between P11 and P13.

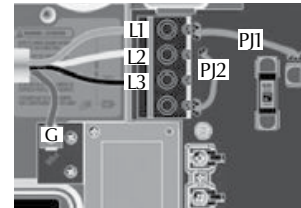

3-phase Delta

Connect P11 between P7 and P10. Connect P2 between P13 and P74.

#### In.ye.ce 230 V or 230/400 V

Correct wiring of the electrical service box, RCD, and pack terminal block is essential!  
Call an electrician if necessary.

#### **Warning!**

In.ye.ce models must always be connected to a circuit protected by a Residual-Current Device (RCD) having a rated operating residual-current not exceeding 30 mA.

### Electrical wiring: in.yt European model

Refer to wiring diagram in the enclosure box lid for more information.

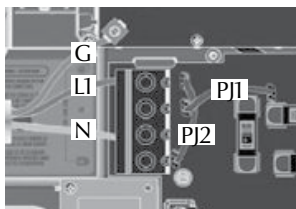

1-phase

Connect P11 between P7 and P13. Connect P2 between P10 and P74.

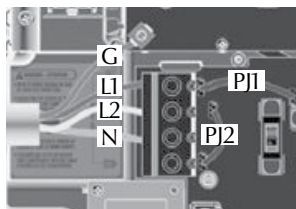

2-phase with single neutral

Connect P11 between P7 and P10. Connect P2 between P13 and P74.

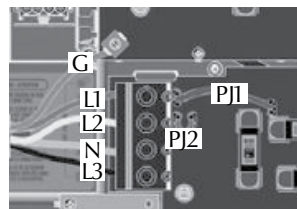

3-phase with single neutral

Connect P11 between P7 and P10. Connect P2 between P11 and P13.

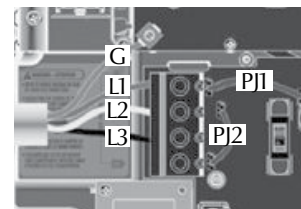

3-phase Delta

Connect P11 between P7 and P10. Connect P2 between P13 and P74.

#### In.yt.ce 230 V or 230/400 V

Correct wiring of the electrical service box, RCD, and pack terminal block is essential!  
Call an electrician if necessary.

#### **Warning!**

In.yt.ce models must always be connected to a circuit protected by a Residual-Current Device (RCD) having a rated operating residual-current not exceeding 30 mA.

## Heater connections

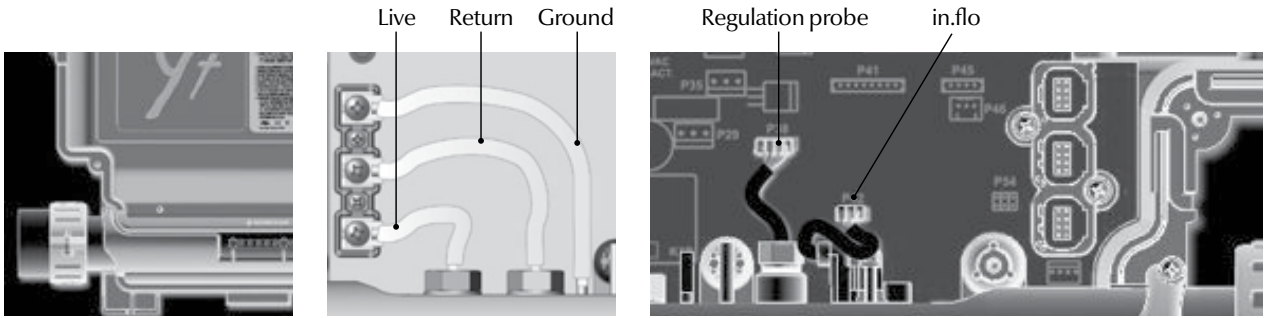

### heat.wav heater

All Y Series systems come with a high performance heat.wav heater. With no pressure switch, it features in.flo integrated dry-fire protection.

The heat.wav heater is factory configured for 240 V / 4 kW, but it can be converted to a dedicated 120 V / 1 kW by simply adding a cable connection (Part #: 9917-101959). (120 V conversion is available on North American in.ye-3 models only).

heat.wav specification summary:

- Supports 120 V or 240 V
- Protected by external breaker (not fused)\*
- Incoloy® heater element
- Optional 5.5 kW (Part #: 9920-101449), 240 V heater is available.

*\*Note: European models are 230-240 V only, and are fuse protected*

All heater connections are accessible when the cover is removed. Connections include the in.flo dry-fire protection, hi-limit/regulation probe connectors, power and ground cable connections.

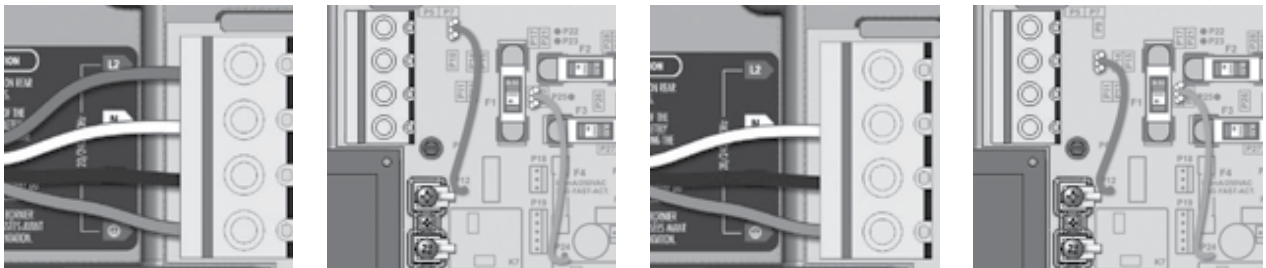

#### Connections for all 240 V heaters (North American installations only)

BROWN wire must be correctly and completely connected between P12 and P9.

*For early North American version installations the YELLOW wire must be between P25 and P20. the ORANGE wire must be between P24 and P16*

#### Connections for all 120 V heaters

BROWN wire must be correctly and completely connected between P12 and P10.

*Note: To convert model to a 120 V system, the white (common) accessory wire must be moved. See wiring diagram for details.*

## Power-up & breaker setting



### IMPORTANT! Read before starting

Turn off the breaker.

Make sure all accessories are linked to the bonding connector and connected to pack.

A minimum flow rate of 18 GPM is required. Make sure that all valves are open in the spa plumbing and that you have good water flow circulation from the primary pump into the heater.

Turn on the breaker.

### in.flo dry-fire protection

At power up, the in.flo detector performs a flow check through the following process:

Pump 1 or circulation pump starts for 2 minutes.

The display will show " \_\_ " during the check flow process. After 2 minutes the system validates proper water flow.

In case of failure, the system tries again. The water temperature is shown on the keypad display. Once the water has reached the set point value plus 0.8°F the heater is turned off.

### Boot up display sequence (Each parameter is displayed for 2 seconds)



Lamp test

All the segments and LEDs light up.



Software number

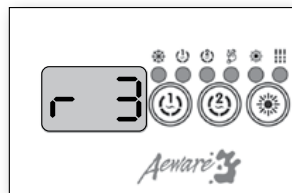

Software revision

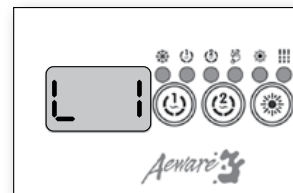

Low-level selection

Low-level selected from low-level menu

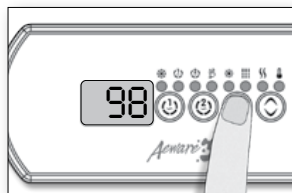

It's important to specify the current rating of the GFCI used to ensure safe and efficient current management (and reduce nuisance GFCI trippings).

Press and hold the **Prog** button until you access the breaker setting menu (programming menu will appear first).

Note: if the keypad in use does not have the **Prog** key, use the **Light** key instead.

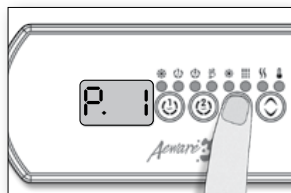

Chose the number of phases supplying your spa. Use the **Up/Down** key to chose the desired value and press the Program or light key to confirme the selection. You can chose between 1, 2 or 3 phases.

#### Number of phase selection

UL	Menu not available
CE	1, 2 or 3
UL Swim*	1 or 2
CE Swim*	1, 2 or 3

\*See Swim Spa manual for details.



The values displayed by the system correspond to 0.8 of the maximum amperage capacity of the GFCI.

Use the **Up/Down** buttons to select the desired value.

The value can typically be modified from 10 to 48 A.



Press the **Prog** button to set breaker rating. This table shows typical settings of b for different GFCI ratings. Select the one that matches your breaker.

GFCI	b
60 A	48 A
50 A	40 A
40 A	32 A
30 A	24 A
20 A	16 A

Note: Every OEM has its own preset configurations.

## High voltage accessory connections

Two options are available with Y Series spa packs for connecting high voltage accessories: 0.250" quick-connect terminals, or AMP pins and housings.

### in.ye

These tabs require high-voltage accessories to have straight, non-insulated, female quick-connect terminals for all connections, including ground. Depending on where the connections are made on the in.ye pack PCB, 120 V and 240 V accessories are supported. Refer to the following tables for correct connections. Note that all female terminal must be correctly and completely seated on the PCB tab for proper current ratings.

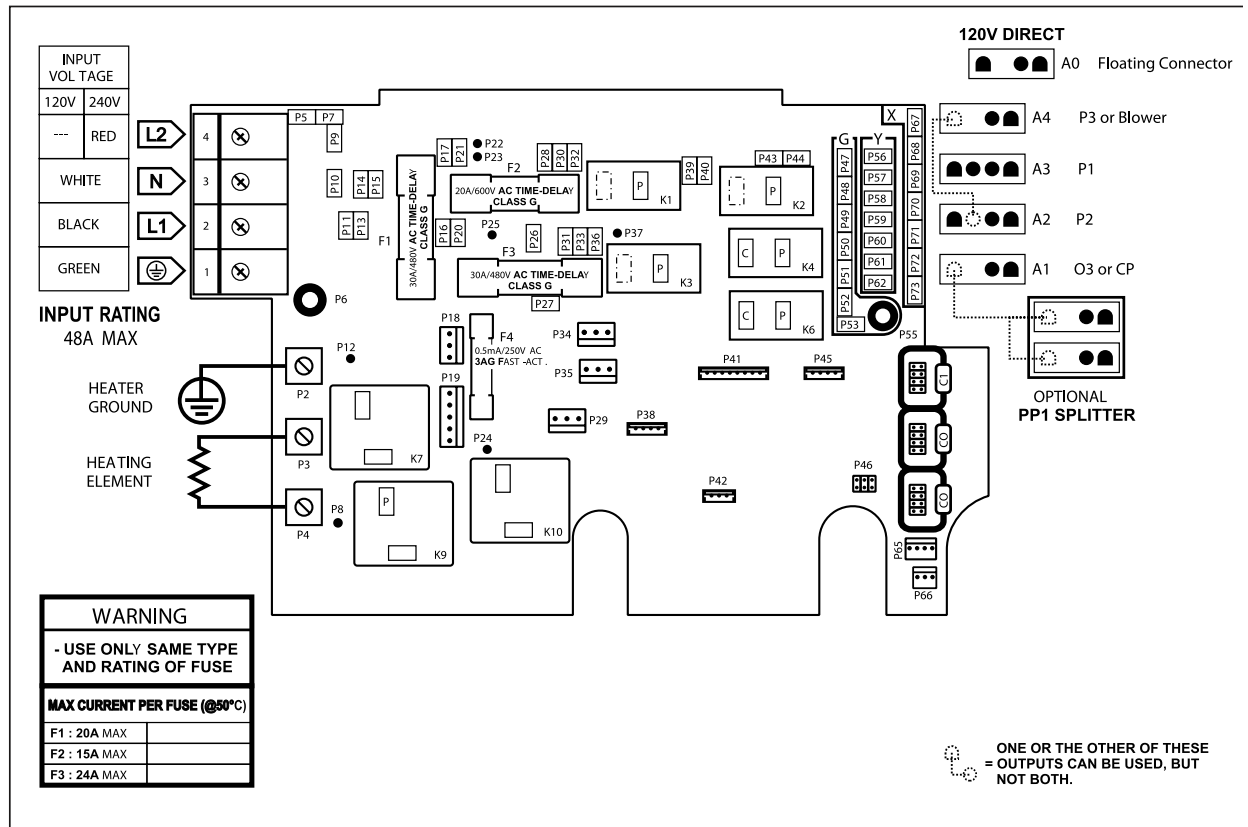

Direct output 1 (in.ye-5 ce only) (Floating connector)		
Voltage	120 V	240 V
Green / ground	P47	P47
Black / line	P32	P32
White / common	P56	P67

Pump 1 (A3)		
Voltage	120 V	240 V
Green / ground	P49	P49
Black / low speed	K2-P	K2-P
White / common	P58	P69

Pump 3 (A4) (in.yt-5 ce only)		
Voltage	120 V	240 V
Green / ground	P48	P48
Black / low speed	K6-P	K6-P
White / common	P57	P68

Ozonator* (A1)		
Voltage	120 V	240 V
Green / ground	P52	P5
Black / line	K1-P	K1-P
White / common	P61	P7

Pump 2 (A2)		
Voltage	120 V	240 V
Green / ground	P51	P51
Black / low speed	K6-P	K6-P
Red / high-speed	K3-P	K3-P
White / common	P60	P71

Circ. pump* (A1)		
Voltage	120 V	240 V
Green / ground	P52	P52
Black / line	K1-P	K1-P
White / common	P61	P72

Blower (A4) (in.ye-5 ce only)		
Voltage	120 V	240 V
Green / ground	P48	P48
Black / line	K6-P	K6-P
White / common	P57	P68

Light (12 V AC, 1A Max.)	
Voltage	
Always on	P34
Relay	P35

\* Ozonator and circ pump can be combined on the same output via the optional splitter PP1.

This table shows typical connections. OEMs may have a different connection scheme.

## Keypad Overview



## in.k300™ Compact full-function keypad

The Quick Reference Card provides an overview of your spa's main functions and the operations accessible from your digital keypad. This QRC depicts a generic overlay, custom versions may vary.

### Description

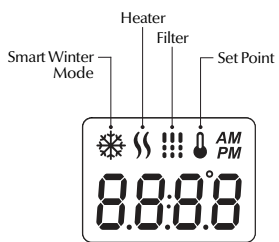

### 1 Pump Model

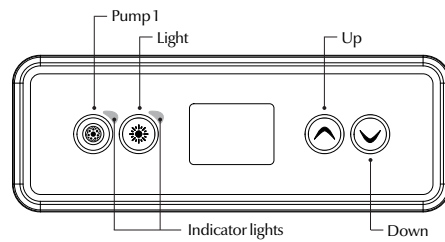

### 2 Pump Model

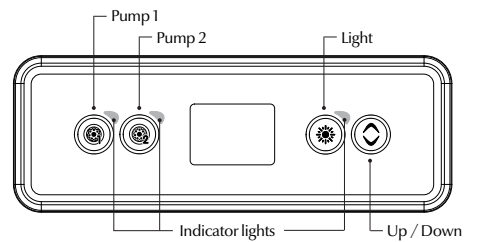

## Spa Functions



### Off Mode

Pressing **Pump 1** for 5 seconds will enable the Off mode. This mode allows you to stop all outputs including automatic functions such as filter cycle, heat request and smart winter mode for 30 minutes to perform quick spa maintenance. When Off mode is active, the display will toggle between the "OFF" message, the clock and the water temperature. The spa light will flash for a few seconds before the end of the 30 minutes to warn you that the system is about to resume its normal operation. Press **Pump 1** or **Pump 2** (if available) to restart the system before the expiration of the 30 minute delay. When the system resumes its normal operation, the display shows "On" for 3 seconds.



### Pump 1

Press **Pump 1** key to turn Pump 1 on at low speed. Press a second time to turn pump to high speed (with a dual-speed pump\*). A third time turns pump off. A built-in timer automatically turns pump off after 20 minutes, unless pump has been manually deactivated first.

The "Pump 1" indicator lights up when Pump 1 is on. With a dual-speed pump, the indicator will flash when pump 1 is on at low speed.

\* If single speed pump: press Pump key to turn pump on. Press Pump key again to turn pump off.



### Pump 2 key

Not available on all models

Press **Pump 2** key to turn Pump 2 on at low speed. Press a second time to turn pump to high speed (with a dual-speed pump\*). A third time turns pump off. A built-in timer automatically turns pump off after 20 minutes, unless pump has been manually deactivated first.

The "Pump 2" indicator lights up when Pump 2 is on. With a dual-speed pump, the indicator will flash when pump 2 is on at low speed.



### Light key

Press **Light** key to turn light on. A second press turns light off. A built-in timer automatically turns light off after 2 hours, unless it has been manually deactivated first.

The "Light" indicator lights up when light is on.



### Up/Down keys

Use **Up** or **Down** key to set desired water temperature. The temperature setting will be displayed for 2 seconds to confirm your new selection.

2 pump spas have a combined **Up/Down** key. Hold the button to increase the parameter and release the button to stop. Hold the button again to decrease the parameter.

 The "Set Point" icon indicates that the display shows the desired temperature, NOT the current water temperature!

**Programming Steps**



**Program menu** ☀

The program menu is accessible by holding down the **Light** key for 5 seconds. In the program menu the following parameters can be set: clock, the filter or purge cycles, economy mode and temperature units. While you are in the program menu, use the **Up** or **Down** key to adjust the parameters and use the **Light** key to jump to the next parameter. The changes will be saved after the confirmation of

the last parameter only. If there is no action taken for 10 seconds, the system will exit the program menu without saving any changes.

**Setting the clock**

Enter the program menu by holding down the **Light** key for 5 seconds. The display will show the current clock setting with the hour flashing.

Depending on factory settings your system may be set to 24-hour time or 12-hour time.

**Setting the hour:** Use the **Up** or **Down** keys to adjust the hours. Press the **Light** key to jump to the next parameter, the minutes.

**Setting the minutes:** Use the **Up** or **Down** keys to adjust the minutes. Press the **Light** key to jump to the next parameter, the filter or purge start time (FS).

**Programming the filter/purge cycles**

Depending on system configuration your spa will perform either a filter or a purge cycle. The filter cycle menu consists of the following parameters: the start time (FS), the duration (Fd) and the frequency (FF). The purge cycle menu consists of the following parameters: the start time (FS) and the frequency (FF).

A filter cycle consists of starting all the pumps and blower in high speed for 1 minute (purge step) then, the pump associated with the filter will run in low speed for the remaining duration of the filter cycle (clean step).

A purge cycle is used when the spa is equipped with a 24 hour circulation pump which provides a continuous clean step. It consists of starting all the pumps and blower in high speed for 1 minute.



**Setting filter or purge cycle start time**

The display will show FSxx, "xx" representing the starting hour of the cycle. Use the **Up** or **Down** key to adjust the hours. Use the **Light** key to jump to the next parameter, filter duration (Fd).

**Setting filter cycle duration**

(not available on purge systems)  
The display will show Fdxx, "xx" representing the duration in hours of the filter cycle. Use the **Up** or **Down** key to adjust the duration. Use the **Light** key to jump to the next parameter, filter or purge frequency (FF).

0 = no filtration  
24 = continuous filtration

It is not recommended to set this to "0".

**Setting filter or purge cycle frequency**

The display will show FFxx, "xx" representing the number of cycles per day. Use the **Up** or **Down** key to adjust the frequency. Use the **Light** key to jump to the next parameter, economy mode (EP).

The "Filter cycle" indicator lights up when filter is on and flashes when suspended.

**Setting economy mode**

This mode allows you to lower the temperature set point of the spa by 20 °F (11 °C) during a certain period of the day.

The display will show EPx, "x" representing the state of the programmed economy (0 = disabled, 1 = enabled). Use the arrow keys to enable or disable economy mode. Use the **Light** key to jump to the next parameter, economy start time (ES).

**Setting economy start time**

The display will show ESxx, "xx" representing the hour at which the economy mode will become active. Use the **Up** or **Down** key to adjust the hour. Use the **Light** key to jump to the next parameter, economy duration (Ed).

When the Economy mode is ON, the display will toggle between the "Eco" message, the time, and the water temperature.

**Setting economy duration**

The display will show Edxx, "xx" representing the duration in hour of the economy mode. Use the **Up** or **Down** key to adjust the hour. Use the **Light** key to jump to the next parameter, temperature unit.

24 = continuous economy



**Setting temperature unit**

Water temperature can be displayed in either Fahrenheit (°F) or Celsius (°C). The display will show F or C.

Use the **Up** or **Down** key to change the setting. Use the **Light** key to save all the parameters.

**Smart Winter Mode**

Our Smart Winter Mode protects your system from the cold by turning pumps on several times a day to prevent water from freezing in pipes.

The "SWM" indicator lights up when freezing is detected and flashes when the purge is active.

**Cooldown**

After heating the spa water to the desired Set Point, the heater is turned off, but its associated pump (Pump 1 low-speed or CP) remains on for a predetermined period of time to ensure adequate cooling of the heating element, prolonging its useful life.

**Water temperature regulation**

Every 15 to 90 minutes the pump will run to ensure accurate water temperature readings as well as avoid heater activation in dry conditions. After verifying pump activation and taking a water temperature reading if required, the system automatically turns the heater on to reach and maintain water temperature at Set Point.

Indicator flashes when taking water temperature reading.



## Water temperature regulation

In a regulation cycle, the system first generates water flow through the heater housing and the plumbing, in order to ensure accurate water temperature readings as well as avoiding heater activation in dry conditions.

After verifying pump activation and taking a water temperature reading if required, the system automatically turns the heater on to reach and maintain water temperature at Set Point.

⌘ The “Heater” indicator lights up when the heater is on. It flashes when there is a request for more heat but the heater has not yet started.

## Smart Winter Mode

Our Smart Winter Mode protects your system from the cold by turning pumps on several times a day to prevent water from freezing in pipes.

❄ The “Smart Winter Mode” indicator lights up when the Smart Winter Mode is on.

## Cooldown

While performing this task, the heater is not allowed to turn on and its icon flashes.

## Troubleshooting

---



**Hr**  
An internal hardware error has been detected in in.xe. Contact dealer or service supplier.



**HL**  
The system has shut the heater down because the temperature at the heater has reached 119°F (48°C). Do not enter the water! Remove the spa cover and allow the water to cool down, then shut power off and power your spa up again to reset the system.



**AOH**  
Temperature inside the spa skirt is too high, causing the internal temperature in the in.xe to increase above normal limits. Open skirt and wait until error clears.



**FLO**  
The system does not detect any water flow while the primary pump is running. Check and open water valves. Check for water level. Clean filter. If the problem persists, call your dealer or service supplier.



**Prr**  
A problem is detected with the temperature probe. Call your dealer or service supplier.



**OH**  
The water temperature in the spa has reached 108°F (42°C). Do not enter the water! Remove the spa cover and allow the water to cool down to a lower temperature. Call your dealer or service supplier if problem persists.

## Hr error message / flow chart & step-by-step



An internal hardware error has been detected

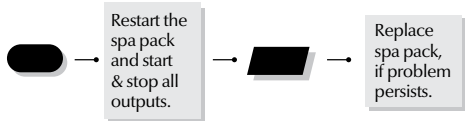

### Step-by-Step

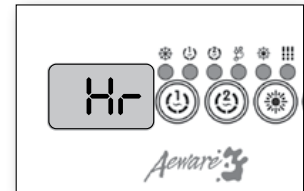

- Restart the spa pack and start & stop all pumps and blower.
- If error reappears, replace the spa pack.

## Prr error message / flow chart & step-by-step



Regulation probe issue

### Flow chart

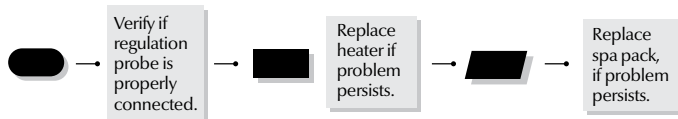

### Step-by-Step

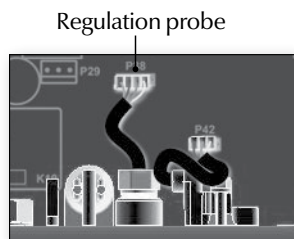
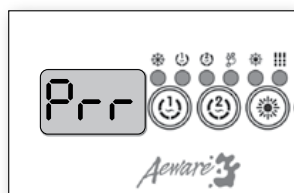

- Verify if regulation probe (located above the heater) is properly connected.
- Replace heater if problem persists.
- Replace spa pack, if problem persists.

# HL error message / flow chart & step-by-step

**HL** The system has shut down because the temperature at the heater has reached 119°F (48°C).

## Flow chart

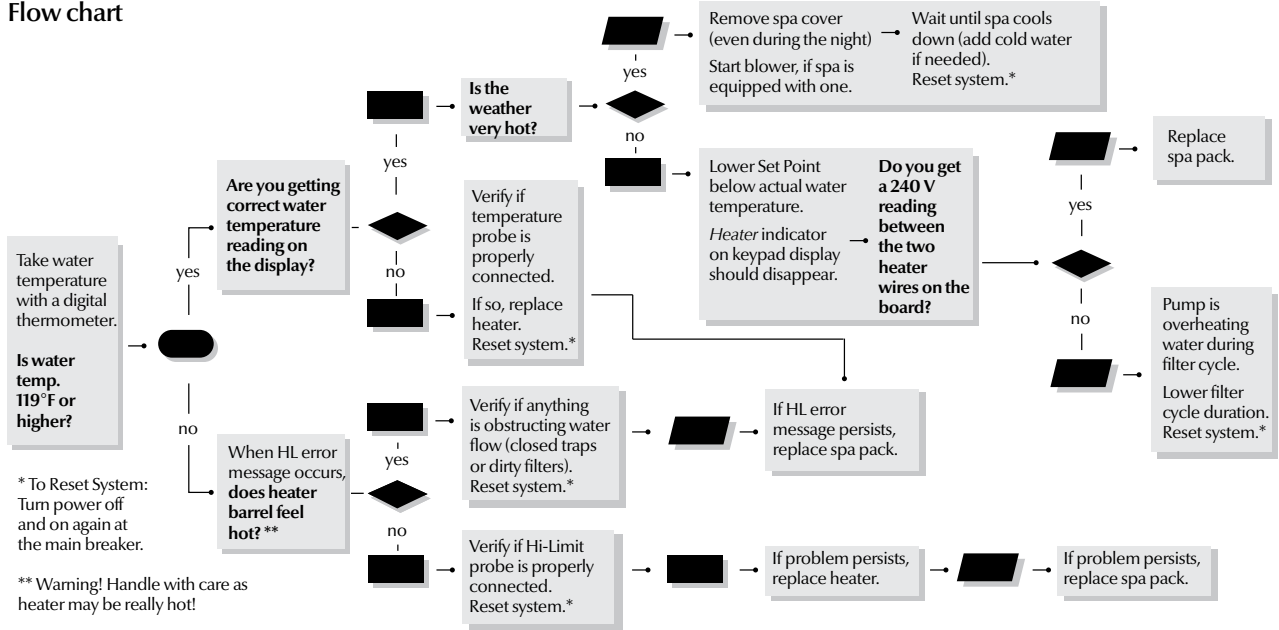

## Step-by-Step

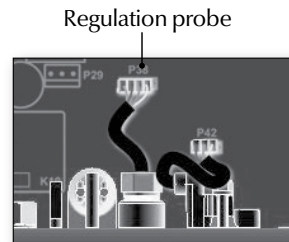

### HL

Water temperature at the heater has reached 119°F

1. Measure the temperature with a DIGITAL thermometer and compare its reading with temp. on the display. Make sure the temp. reading is lower than 119°F.
2. If reading is below 119°F:
  - Carefully check if heater barrel feels hot. If it's hot, verify if anything is obstructing water flow (closed valves or dirty filter).
  - Shut power off and power the spa up again to reset the system.
  - If HL error persists, replace heater.
  - If HL error persists, replace spa pack.
3. If reading is 119°F or higher:
  - Verify if the Temp. & High Limit probes are properly connected.
  - Shut power off and power the spa up again to reset the system.
  - If problem persists, replace heater.
  - If problem persists, replace spa pack.

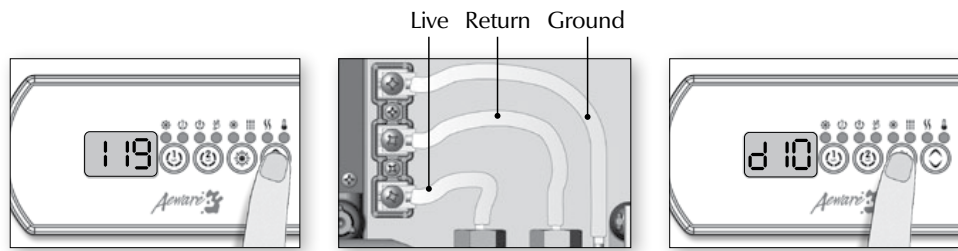

**If weather is very hot:**

1. Remove spa cover (even during the night). Start blower if spa is equipped with one. Wait until spa cools down (add cold water if necessary).
- Shut power off and power the spa up again to reset the system.

**If hot weather is not a factor:**

2. Lower Set Point below current water temperature.  
  
The Heater indicator should disappear from keypad display.

3. With a voltmeter, read voltage between the live and ground heater terminals.
4. If you do read 240 V, replace spa pack.
5. If you do not read 240 V, pump may be overheating water during filter cycle.

Shorten filter cycle duration.

**To shorten filter cycle duration:**

6. Press and hold the **Light** key for 5 seconds. Display will show a value that represents the filter cycle duration in hours.
7. Use the **Down** arrow key to lower the number of hours.  
0 = no filtration  
12 = continuous filtration

When the desired setting is displayed, Press the **Light** key again. The filter cycle will start immediately.

## FLO & UPL error message / flow chart & step-by-step

**FLO**

The system did not detect any water flow while the primary pump was running. Follow the troubleshooting flow chart below to identify the problem:

Make sure that the low-level programming has been properly set, with or without circulation pump (depending on your system configuration).

### Flow chart

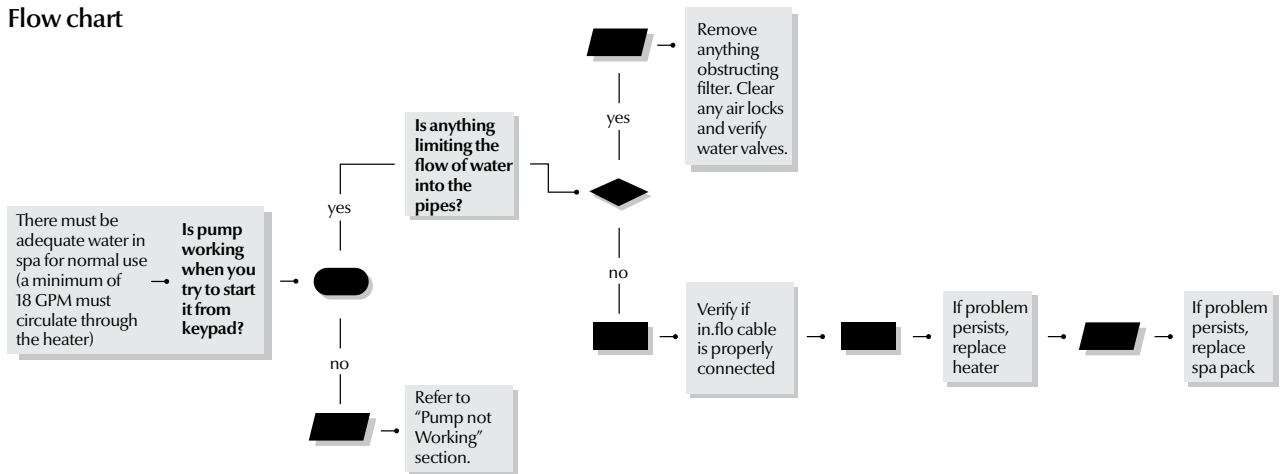

### Step-by-Step

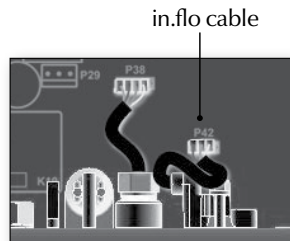

### FLO

**Primary pump is activated, but the system doesn't detect any water flow**

- Make sure water valves are open and that water level is high enough.
- Check and remove anything obstructing the filter.
- Make sure there is adequate flow and that no airlocks are trapped in the unit's plumbing. Pumps may make strange noises. If airlocks are formed, start the pump and slowly loosen one of the union nuts to release the air trapped in the plumbing. Tighten the nut again after you are done.
- Make sure that the pump associated to the heater (primary pump) is running.
- Make sure the in.flo cable (located above the heater) is properly connected.
- If problem persists replace heater.
- If the problem is not solved replace the spa pack.

## OH error message / flow chart & step-by-step



Water temp. in the spa has reached 108°F

### Flow chart

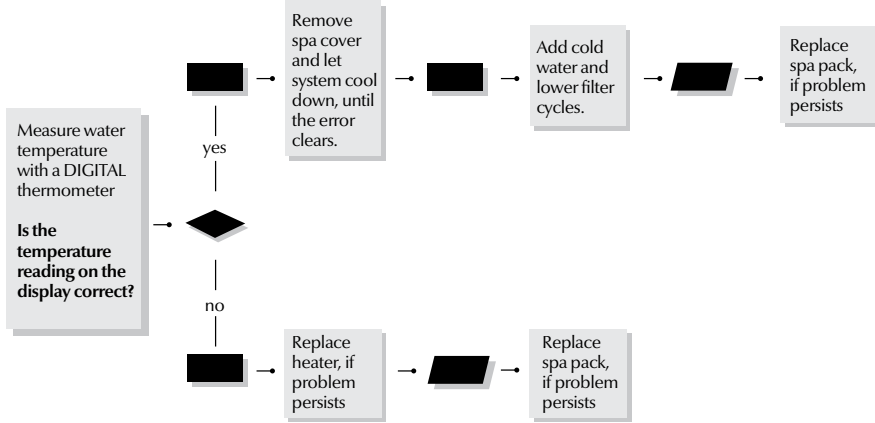

### Step-by-Step



- Measure water temperature with a DIGITAL thermometer and compare its reading with temp. on the display. If temp. reading is different, replace heater.
- Remove spa cover and let spa cool down.
- Add cold water and lower filter cycles.
- If problem persists replace spa pack.

## UPL error message / Step-by-Step



No low-level configuration software in system!

### Step-by-Step



- New low-level configuration software needs to be downloaded into the spa system; without it the system will not be operable.
- Contact our toll free line for technical support (1-800-784-3256).

*Note: this line is dedicated to assist authorized service technicians and dealers only.*

# Troubleshooting

## Pump 1 doesn't work / flow chart & step-by-step

If Pump 1 is not working, follow this troubleshooting flow chart:

### Flow chart

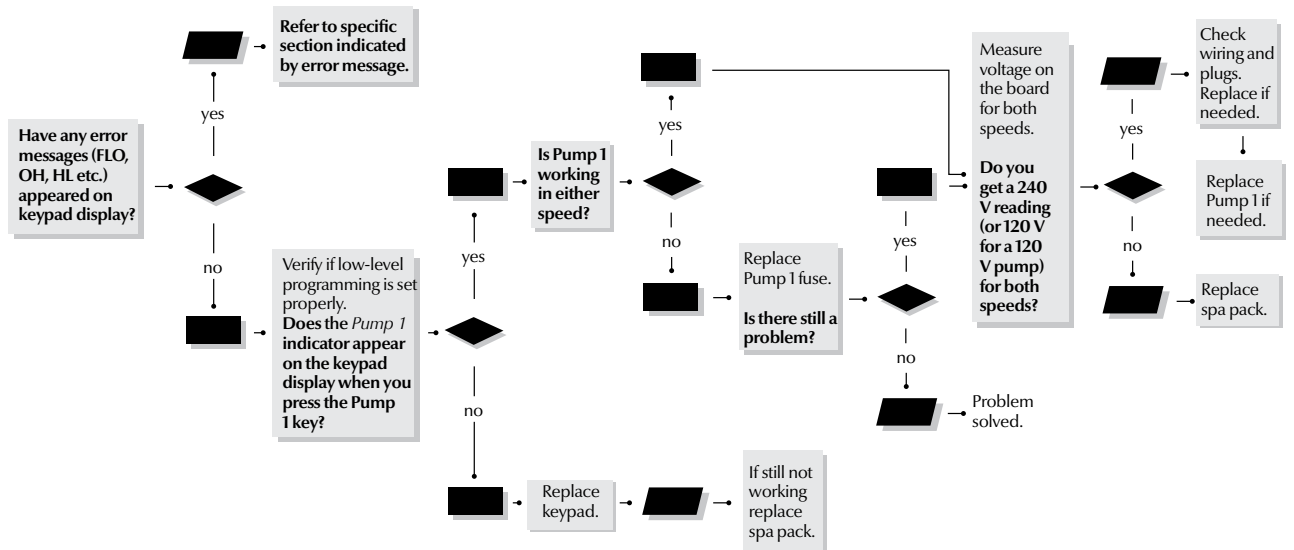

### Step-by-Step

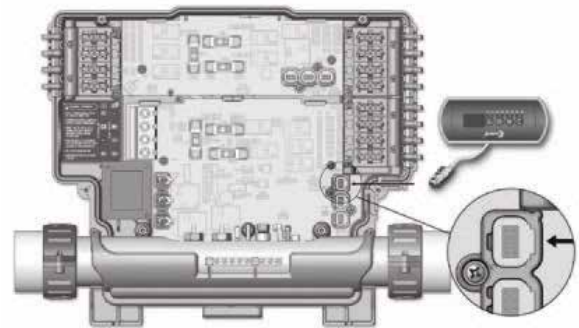
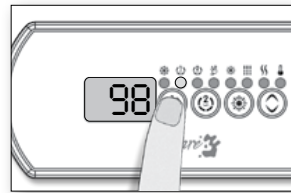

### Pump 1 does not work!

- Check for an error message on keypad display. If there is one, refer to the specific section indicated by the error message.
- Verify low-level programming configuration.
- Verify if the Pump 1 indicator appears on keypad display when you press Key 1.
- If the Pump 1 indicator does not appear, use a spare keypad to verify if keypad is defective. If it is, replace keypad. If not, replace spa pack.
- If Pump 1 indicator appears when Key 1 is pressed, verify if pump works in either speed.

Pump 1 low speed fuse (F2)\*

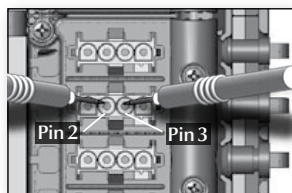
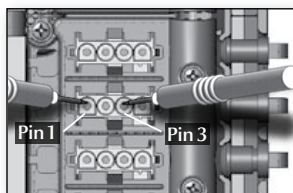
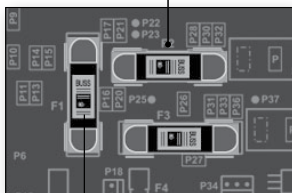

Pump 1 high speed fuse (F1)

- If Pump 1 does not work in either speed, replace appropriate Pump 1 fuse.
- If replacing the fuse is not effective or if Pump 1 works in only one speed, take voltage reading on the corresponding in.link connector.

*\*Pump 1 high and low speed are F2 on the CE version.*

- Turn Pump 1 to high speed and take voltage reading between:

Pin 1 & Pin 3

Your reading should be:

240 V for a 240 V pump

120 V for a 120 V pump

- Turn Pump 1 to low speed and take voltage reading between:

Pin 2 & Pin 3

Your reading should be:

240 V for a 240 V pump

120 V for a 120 V pump

- If voltage is as it should be, replace Pump 1.
- If not, replace spa pack.



## Pump 2 or blower doesn't work / flow chart & step-by-step

If Pump 2 or blower is not working, follow this troubleshooting flow chart:

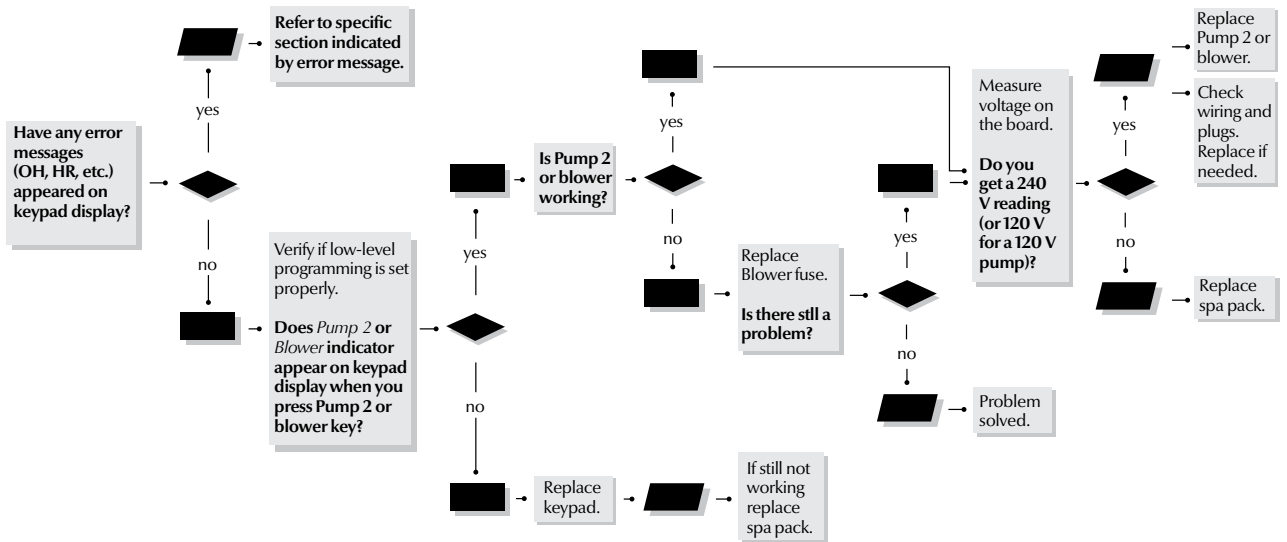

### Step-by-Step

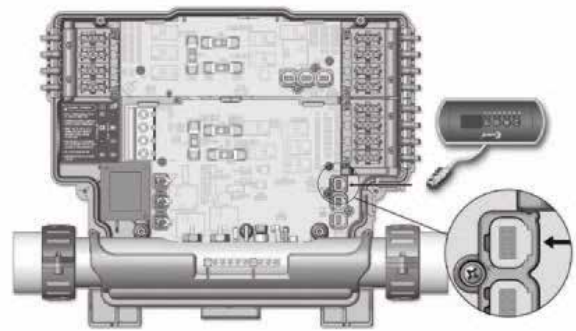
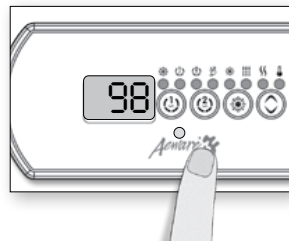

### Pump 2 or blower is not working!

- Check for an error message on keypad display. If there is one, refer to the specific section indicated by the error message.
- Verify low-level programming configuration.
- Verify if Pump 2 or Blower indicator appears on keypad display when you press Key 2 button.
- If Pump 2 or Blower indicators do not appear, use a spare keypad to verify if keypad is defective. If it is, replace keypad. If not, replace spa pack.
- If Pump 2 indicator appears when Key 2 is pressed, verify if pump works in either speed (if dual speed pump).

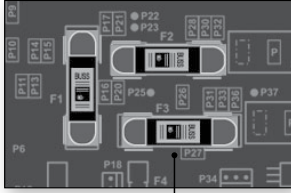

Pump 2 fuse (F3)

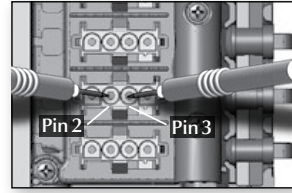
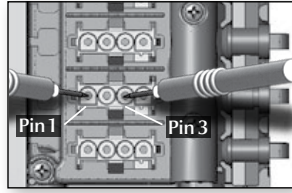

- If Pump 2 does not work in either speed, replace Pump 2 fuse.
- If replacing the fuse is not effective or if Pump 2 works in only one speed, take voltage reading on the corresponding AMP connector.

- Turn Pump 2 to high speed and take voltage reading between:

Pin 1 & Pin 3

Your reading should be:

240 V for a 240 V pump

120 V for a 120 V pump

- Turn Pump 2 to low speed and take voltage reading between:

Pin 2 & Pin 3

Your reading should be:

240 V for a 240 V pump

120 V for a 120 V pump

- If voltage is as it should be, replace Pump 2.
- If not, replace spa pack.

# Circulation pump doesn't work / flow chart & step-by-step

If circulation pump is not working, follow this troubleshooting flow chart:

## Flow chart

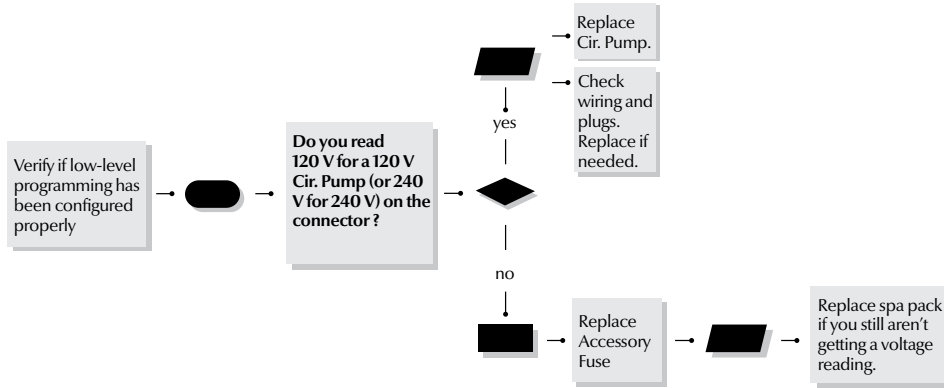

in.yt model

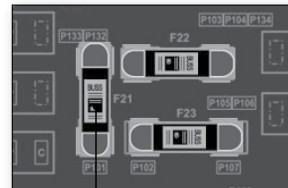
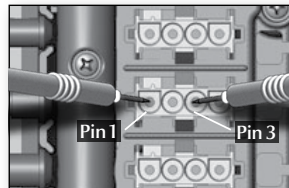

Circulation pump fuse (F21)

## Step-by-Step

in.ye model

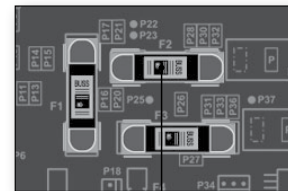
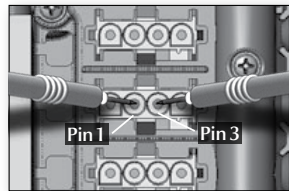
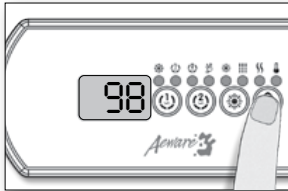

Circulation pump fuse (F2)

## If circulation pump is not working:

- Verify low-level programming configuration.
- Start circulation pump by setting temperature set point 2 °F higher than actual water temperature.
- Take voltage reading on the corresponding AMP connector:  
Pin 1 & Pin 3  
Your reading should be:  
240 V for a 240 V pump  
120 V for a 120 V pump
- If you don't get a voltage reading, replace the accessory fuse.
- If changing the fuse does not fix the problem, replace the spa pack.
- If voltage is as it should be, replace circulation pump.

## Ozonator doesn't work / flow chart & step-by-step

If the ozonator is not working, follow this troubleshooting flow chart:

Ozonator output will be shut down when Pump 1, Pump 2 or blower have been turned on manually.

### Flow chart

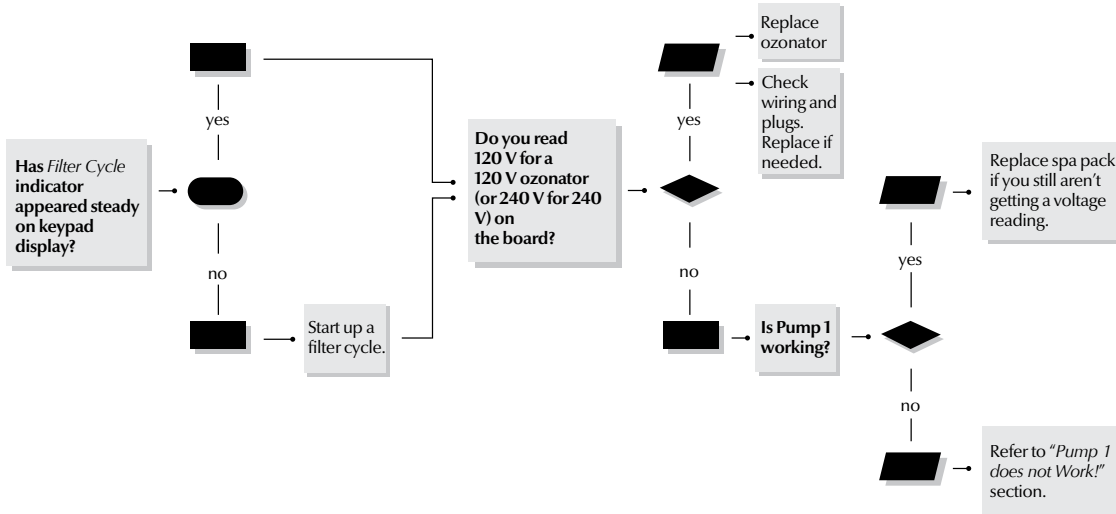

### Step-by-Step

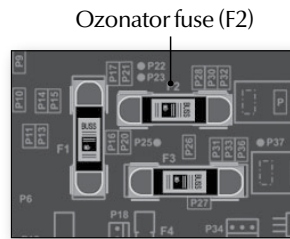
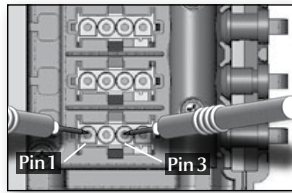
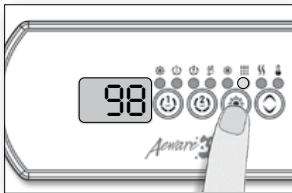

### If the ozonator is not working:

- Check if Filter Cycle indicator appears steady on keypad.
- If the filter indicator is blinking it indicates that the filter cycle has been interrupted. In that case, reset the breaker by turning the power off and on again to resume cycle.
- If not, start up a filter cycle (see Programming Filter Cycles section).
- If ozonator does not work even when filter cycle indicator is on, take voltage reading on the corresponding AMP connector:  
Pin 1 & Pin 3  
Your reading should be:  
240 V for a 240 V pump  
120 V for a 120 V pump
- If you don't get a voltage reading, replace the accessory fuse.
- If changing the fuse does not fix the problem, replace the spa pack.
- If voltage is as it should be, replace ozonator.

## Nothing seems to work / flow chart & step-by-step

If nothing seems to work, turn off the main breaker and visually inspect power input cable, gently pulling on it to make sure is properly tightened. Turn the main breaker back on and follow this troubleshooting flow chart:

### Flow chart

#### For North American systems

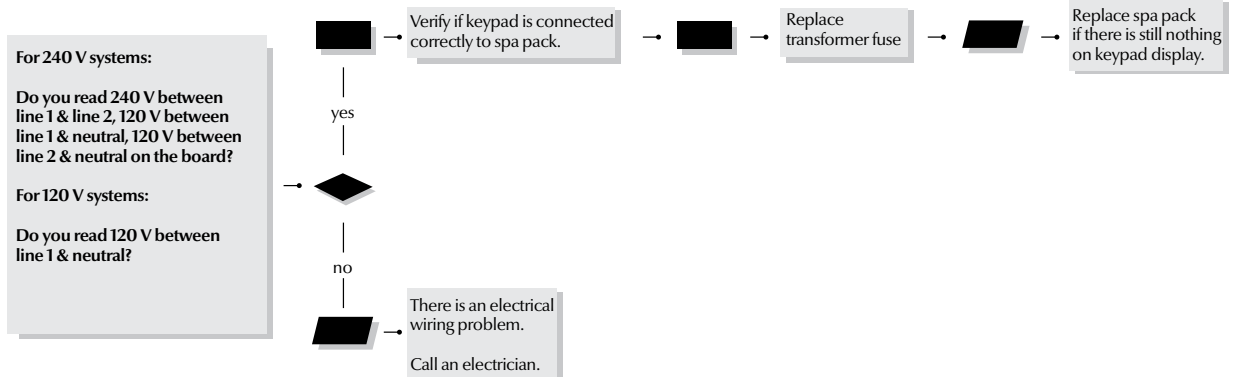

### Step-by-Step for North American version

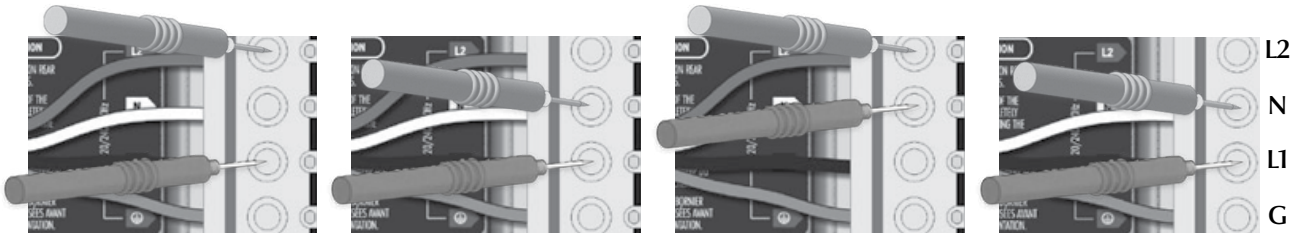

#### Nothing seems to work!

- Verify that all screws are properly tightened on the terminal block. Turn power off and make sure that all cables hold firmly in the terminal block if you pull on them. Once done, turn power back on.
- On the terminal block, measure voltage between line 1 and line 2.
- You should get 240 V.

- Measure voltage between line 1 and neutral.
- You should get 120 V.

- Measure voltage between line 2 and neutral.
- You should get 120 V.
- If you do not get good readings, this indicates an electrical wiring problem.

**Call an electrician!**

#### For 120 V systems

- Measure voltage between line 1 and neutral.
- You should get 120 V.
- If you do not get good readings, this indicates an electrical wiring problem.

**Call an electrician!**

## Nothing seems to work (European version)/ flow chart

If nothing seems to work, turn off the main breaker and visually inspect power input cable, gently pulling on it to make sure is properly tightened. Turn the main breaker back on and follow this troubleshooting flow chart:

### Flow chart For European systems

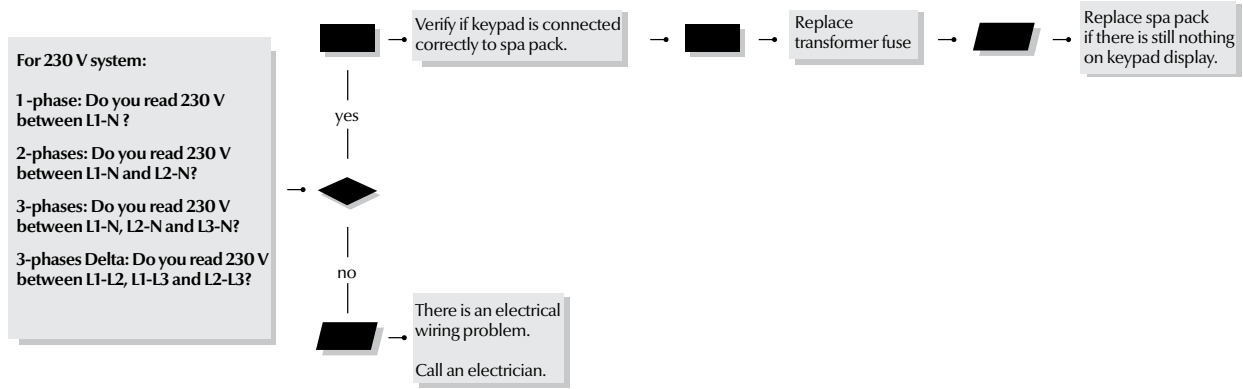

## Step-by-Step

### Nothing seems to work!

Verify that all screws are properly tightened on the terminal block. Turn power off and make sure that all cables hold firmly in the terminal block if you pull on them. Once done, turn power back on.

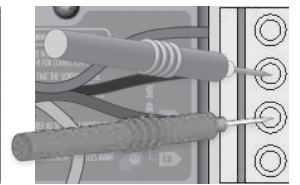
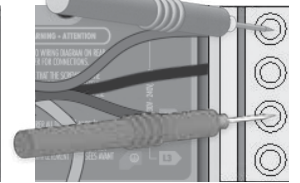
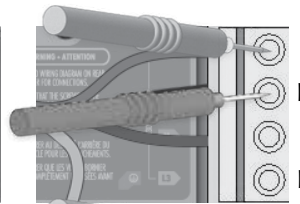
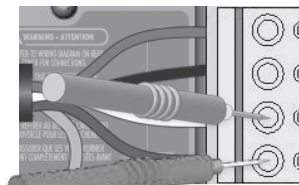
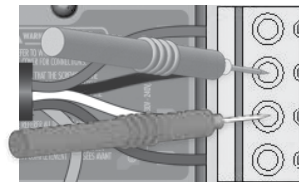
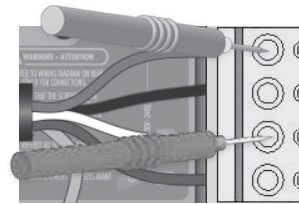
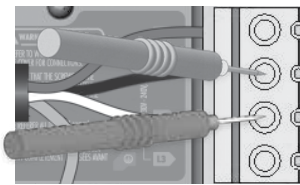
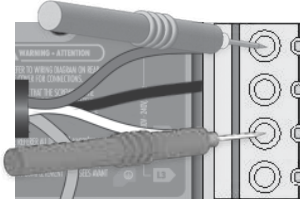
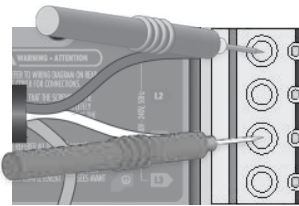

### For 1-phase system

- On the terminal block, measure voltage between line 1 and neutral.
- You should get 230 V.
- If you do not get good readings, this indicates an electrical wiring problem.

**Call an electrician!**

### For 2-phase system

- Measure voltage between line 1 and neutral and between line 2 and neutral.
- You should get 230 V on both readings.
- If you do not get good readings, this indicates an electrical wiring problem.

**Call an electrician!**

### For 3-phase system

- Measure voltage between line 1 and neutral, between line 2 and neutral and between line 3 and neutral.
- You should get 230 V for each reading.
- If you do not get good readings, this indicates an electrical wiring problem.

**Call an electrician!**

### For 3-phase Delta system

- Measure voltage between line 1 and line 2, between line 1 and line 3 and between line 2 and line 3.
- You should get 230 V for each reading.
- If you do not get good readings, this indicates an electrical wiring problem.

**Call an electrician!**

If the voltage reading are OK then:

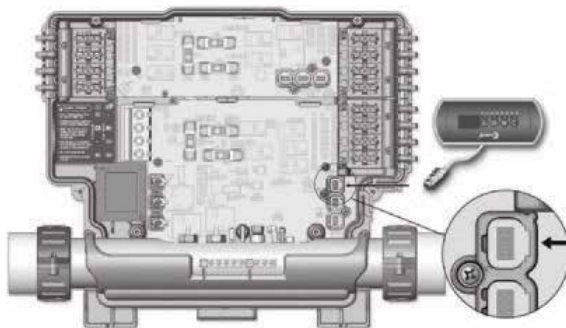

- Verify if keypad is correctly connected to the spa pack.

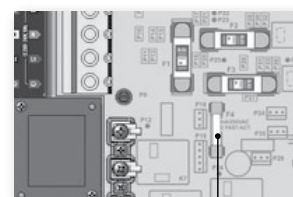

Transformer fuse

- Verify the transformer fuse.
- Replace transformer fuse if necessary.
- If problem persists, replace spa pack.

## Spa not heating / flow chart & step-by-step

If spa is not heating, follow this troubleshooting flow chart:

### Flow chart

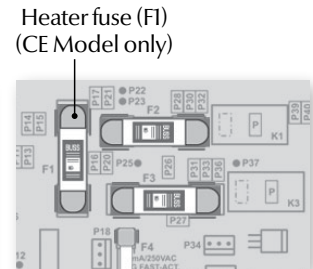
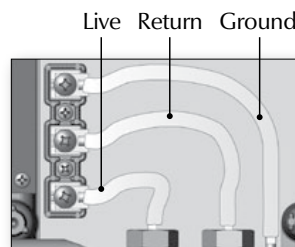
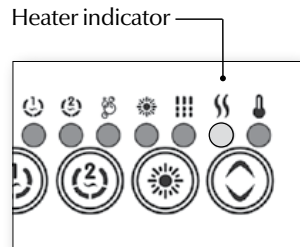
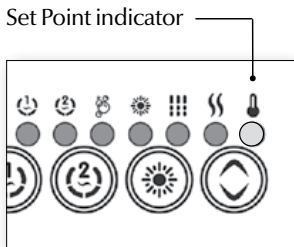
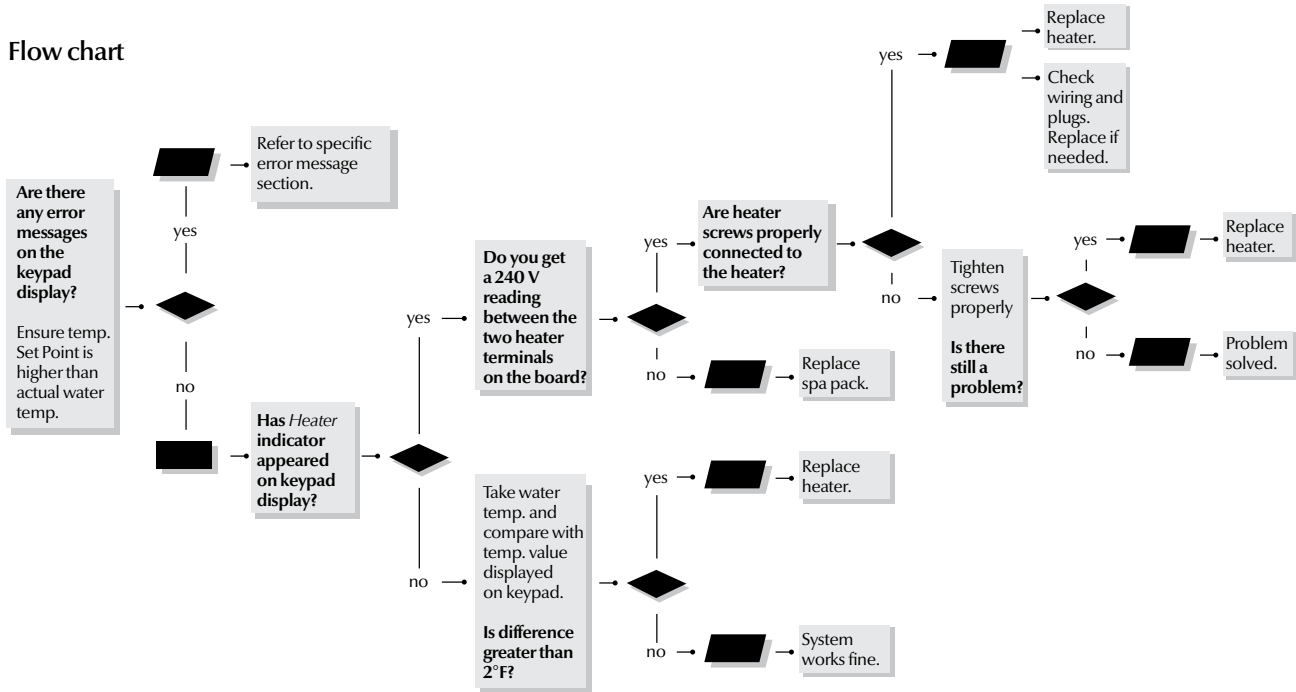

### Spa not heating!

- Check for an error message on keypad display. If there is one, refer to specific section indicated by the error message.
- If there is no error message, try to raise water temperature by increasing the Set Point 2°F higher than actual water temperature. Press Up key to increase Set Point.
- Verify if Heater indicator appears on keypad display.
- The heater indicator will be on when heater is on. It will flash if more heat has been requested, but heater has not started yet.
- If heater indicator lights up on the display, take voltage reading between the heater live and return terminals.
- If voltage reading is not as it should be, verify if heater terminals are properly connected .
- If it is, replace spa pack.
- In the case of the European model in.yt.ce only, replace accessory fuse.
- If problem persists, replace spa pack.

Your reading should be:  
 240 V: for 240 V heaters  
 120 V: for 120 V heaters



## Keypad doesn't seem to work step-by-step

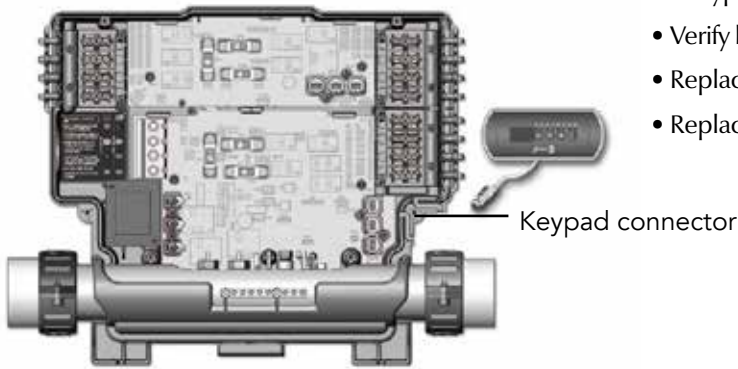

If a keypad doesn't work:

- Verify keypad connections and try spare keypad.
- Replace keypad if problem is corrected.
- Replace pack if problem is not corrected.

## GFCI trips

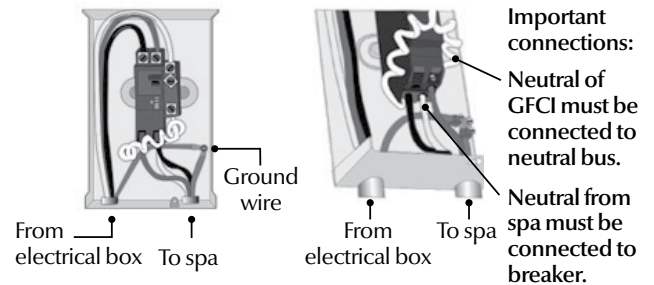
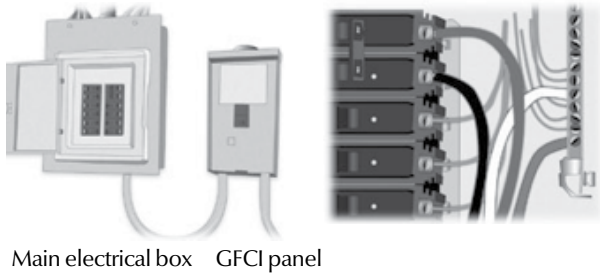

### ⚠ Warning!

**Total current output cannot exceed total current input rating!**

There are different GFCI models used on the market. See manufacturer's instructions that come with the GFCI for specific information. Note that all illustrations are examples only.

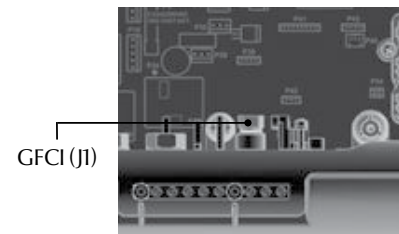

The Y Series packs are equipped with a GFCI tripper circuit in case an HL error occurs.

- Find the GFCI tripper circuit (J1) on the board located behind the temperature probe and remove the jumper.
  - Activate the GFCI and see if an error occurs. If HL appears, follow the HL error troubleshooting chart (in the Troubleshooting section).
  - If no error occurs, re-install the jumper.  
If the GFCI trips again replace the pack.
- If the GFCI is still tripping, the error doesn't come from the GFCI tripper circuit.
- Verify that the GFCI circuit is properly connected.

- If it's not, reconnect it.
- Verify the spa pack wiring (make sure that the neutral and the ground have not been inverted)

If the GFCI is properly connected but still tripping,

- Unplug all outputs from the spa pack (pumps, blower, heater, ozonator etc).
- If it doesn't trip while all outputs are unplugged, reconnect one output at a time until the GFCI trips again.
- Replace defective component.

*Note: Incorrect GFCI wiring may lead to a condition where the GFCI may NOT trip when it should, causing electrical shock hazard. All electrical installations should be done by qualified personnel only.*

# Water Maintenance

It's important to have clean water. Water maintenance is one of the least understood, but very important areas of spa ownership. Your dealer can guide you through the process of achieving and maintaining perfect water in your spa, given your local conditions. Your program will depend on your water's mineral content, how often you use your spa, and how many people use it. Here is our suggested step-by-step program:

## General Information

There are three fundamental areas of water maintenance. They are (1) Water Filtration, (2) Water Sanitation, and (3) Chemical Balance/pH Control.

Although your spa's filter system is working several hours a day to remove particles from your water, it does not remove bacteria or viruses. Water sanitation is the responsibility of the spa owner. It can be achieved through the regular and periodic (daily, if necessary) addition of an approved sanitizer. The sanitizer will chemically control the bacteria and viruses present in the spa water. Bacteria and viruses can grow quickly in under sanitized spa water. The water's chemical balance and pH control are also the responsibility of the spa owner. You will have to add chemicals to maintain proper levels of Total Alkalinity (TA), Calcium Hardness (CH) and pH. Proper water balance and pH control will minimize scale buildup and corrosion of metals, extend the life of the spa, and allow the sanitizer to work at maximum efficiency.

**For Onzen System: Please refer to your Onzen User Guide for direction in water maintenance.**

**For Spa Boy System: Please refer to your Spa Boy Owners manual for directions in water maintenance.**

## Methods For Testing The Spa Water

Accurate water testing and analysis are an important part of effectively maintaining your spa water. To follow the Arctic Spas® recommended program, you must have the ability to test for:

- Total Alkalinity (TA)
- Calcium Hardness (CH)
- pH
- Sanitizer

Although reagent liquid test kits provide the highest level of accuracy, Test Strips are the most convenient testing method used by many spa owners. Keep in mind that test strips are susceptible to heat and moisture contamination, which will result in inaccurate readings. Very high sanitizer levels will also render test strips unreliable.

**IMPORTANT:** Always read and carefully follow the directions included with the Test Kit or Test Strips to ensure the accuracy of the test results.

## Hints For Successful Water Testing

When using the reagent test kit:

- Always take water samples 30-45 cm (12" - 18") below the water surface.

- 
- Rinse the test cells before and after each use.
  - Do not dispose of test samples into the spa water.
  - When adding drops of chemicals from the kit (the reagents) into the test block, hold the bottle vertically and add the drops slowly to be sure the correct quantity is used.
  - The reagents should be replaced on a yearly basis to maintain the accuracy of the test results.

### **Basic Chemical Safety**

When using chemicals, read the labels carefully and follow directions precisely. Though chemicals protect you and your spa when used correctly, they can be hazardous in concentrated form. Always observe the following guidelines:

- ALWAYS KEEP CHEMICALS OUT OF CHILDREN'S REACH.
- NEVER MIX CONCENTRATED CHEMICALS TOGETHER.
- ALWAYS THOROUGHLY RINSE ANY CONTAINER USED TO MIX CHEMICALS AFTER USE.
- ALWAYS RINSE OUT ANY EMPTY CHEMICAL STORAGE CONTAINER BEFORE DISPOSAL.
- Accurately measure the quantities specified. Do not overdose your spa. Amount required will vary depending on water condition, quantities to be used are only guidelines.
- Store chemicals in a cool, dry, well ventilated place.
- Always keep chemical containers closed when not in use.
- Don't inhale fumes or allow chemicals to come in contact with your eyes, nose, or mouth. Wash your hands immediately after use.
- Follow the emergency advice on the product label in case of accidental contact.
- Never smoke around chemicals. Some fumes can be flammable.
- Don't store any chemicals in the spa equipment compartment.

### **Adding Chemicals to the Spa**

Most chemicals (does not include any slow dissolving chemicals) can be added directly to the spa while the pump(s) is running on high speed, for a minimum of 10 minutes.

### **IMPORTANT WHEN USING ARCTIC PURE® BOOST OR REFRESH TREATMENT**

**NOTE:** After administering a super chlorination treatment or non-chlorine shock to your spa, leave the cover open for a minimum of 20 minutes to allow the oxidizer gas to vent. A high concentration of trapped oxidizer gas which may exist as a result of the shock treatment (not daily sanitation) may eventually cause discoloration or vinyl degradation to the bottom of the cover. This type of damage is considered chemical abuse and is not covered under warranty.

### **The Arctic Pure® Water Maintenance Program**

Following the Arctic Pure® water maintenance program will save you time and frustration and ensure clear, clean spa water.

### **Remove Excess Minerals**

Most tap water has minerals such as Calcium, Copper, Iron, Manganese and Sodium in it, and the

circulation of water can cause the erosion of metals from spa equipment which can present possible scaling and staining problems in your spa. Cases of source water with high minerals (such as some well water):

1. We recommend you add 3 1/2 tablespoons (48 grams) of Arctic Pure® Best Defense per 1000 litres (265 gallons) of water while filling your spa.
2. Also, as water evaporates from your spa and new water is added, the amount of dissolved minerals will increase. The spa water may eventually become “hard” (Calcium Hardness too high) enough to damage the heater by calcifying its surface. To protect against these problems add 1 tablespoon (14 grams) per 1000 litres (265 gallons) of Arctic Pure® Best Defense weekly.

### **Balance the Total Alkalinity (TA)**

1. The recommended Total Alkalinity (TA) for your spa water is 80-120 ppm.
2. Total Alkalinity is a measure of the total levels of carbonates, bicarbonates, hydroxides, and other alkaline substances in the water. TA is referred to as the water’s “pH buffer”. In other words, it’s a measure of the ability of the water to resist changes in pH level.
3. If the TA is too low, the pH level will fluctuate widely from high to low. Fluctuations in pH can cause corrosion or scaling of the spa components. Low TA can be corrected by adding Arctic Pure™ Perfect Balance.
4. If the Total Alkalinity is too high, the pH level will tend to be high and may be difficult to bring down. The pH can be lowered by using Arctic Pure® Adjust Down.
5. Once the TA is balanced, it normally remains stable, although some sanitizers, and the addition of more water with a high or low alkalinity will raise or lower the TA reading of the water.
6. When the Total Alkalinity is within the recommended range, proceed to the next step.

### **Balancing the pH**

1. We recommended a pH range for your spa water of; 7.2-7.6.
2. The pH level is the measure of acidity and alkalinity. Values above 7 are alkaline; those below 7 are acidic. Maintaining the proper pH level is extremely important for:
  - Optimizing the effectiveness of the sanitizer.
  - Maintaining water that is comfortable for the user.
  - Preventing equipment deterioration.
  - Preventing cloudy or odorous water.
3. If the spa water’s pH level is too low, the following may result:
  - The sanitizer will dissipate rapidly.
  - The water may become irritating to spa users.
  - The spa’s equipment may corrode.

If the pH is too low, it can be increased by adding Arctic Pure® Adjust Up to the spa water.

4. If the pH level is too high, the following may result:
  - The sanitizer is less effective.
  - Scale will form on the spa shell surface and the equipment.
  - The water may become cloudy.

---

If the pH is too high, it can be decreased by adding Arctic Pure® Adjust Down to the spa water.

5. It is important to check the pH on a regular basis. The pH will be affected by the bather load, the addition of new water, the addition of various chemicals, and the type of sanitizer used.
6. When the pH is within the recommended range, proceed to the final step.

## Calcium Hardness (CH)

1. Most spa manufacturers recommend a Calcium Hardness (CH) level for your spa of 150-200 ppm. However, we do not recommend adding calcium to your spa if your spa water is above 100 ppm, or if your incoming water has a very low level of calcium hardness.
2. Calcium Hardness is a measure of the total amount of dissolved calcium in the water. It is believed that calcium helps control the corrosive nature of water. Calcium has a tendency to precipitate (fall out of suspension) in high temperatures and high pH levels.

**Warning:** When calcium falls out of suspension it can collect on the heater and pump, and shorten their life.

3. Any natural corrosiveness in the water can be combatted by maintaining a slightly higher Total Alkalinity Level.

## Sanitize the Spa

Sanitizer is extremely important for killing algae, bacteria and viruses, and preventing unwanted organisms from growing in the spa. At the same time, you don't want too high a sanitizer level, or it can irritate your skin, lungs and eyes.

1. Always maintain the sanitizer level in your spa at the recommended level for each type of sanitizer.
2. We recommend the following sanitizers:

Chlorine System:

- Arctic Pure® Chlorine Tablets
- Arctic Pure® Refresh
- Arctic Pure® Boost

Bromine System:

- Arctic Pure® Brominating Tablets
- Arctic Pure® Refresh
- Arctic Pure® Peak Boost

**Important:** Sanitizers are acidic and will decrease the Total Alkalinity. Regular testing and balancing of TA is extremely important with these products.

**Important: Always remove the floating dispenser while the spa is in use.** Remove dispensers with a plastic bucket (keeping submerged) and store out of reach of children until spa use has ended.

## Using Chlorine System

**CAUTION:** The use of personal protective equipment (rubber/latex/vinyl gloves, eye protection) is recommended while handling the dispenser or the pucks.

**Start-up:**

1. Add pucks to floating dispenser and open to setting 4.
2. Add 7 tablespoons (100 grams) of Arctic Pure® Refresh per 1500 litres (396 gallons) of water.
3. Add 1 tablespoon (14 grams) of Arctic Pure® Spa Boost per 1000 litres (265 gallons) of water.
4. Test the Chlorine level. Once the chlorine reads within the ideal range (1-3 ppm) turn tablet dispenser down to 1 - 2 (more or less according to bather load).
5. Start the Boost Filtration mode to circulate the chemicals and do not use spa for two hours after the mode ends.

*Note:* The above example is for a spa without an ozone system. If your spa is equipped with an ozone system please contact your dealer for proper Chlorine levels.

**Weekly:**

1. Add pucks to floating dispenser and reset the setting if necessary.
2. Add 7 tablespoons (100 grams) of Arctic Pure® Refresh per 1500 litres (396 gallons) of water.
3. Wait at least one hour and add 1 tablespoon (14 grams) of Arctic Pure® Best Defence per 1000 litres (265 gallons) of water.

**Important:** Arctic Pure® Refresh significantly reduces pH and TA. One hour after adding Arctic Pure® Refresh test and adjust TA and pH as needed.

**Bromine System:**

*Note:* If you are planning to use your new spa right away, Peak Boost must be added first. Follow directions for adding Peak Boost from this page.

1. Fill floating dispenser with pucks and open to setting 7.
2. Add 7 tablespoons (100 grams) of Arctic Pure® Refresh per 1500 litres (396 gallons) of water.
3. Add 2 1/2 tablespoons (35 grams) of Arctic Pure® Peak Boost per 1000 litres (265 gallons) of water, to establish a Bromide reserve.
4. Test the Bromine level. Once bromine reads within the ideal range (3-5 ppm) turn tablet dispenser down to 2 or 3 (more or less according to bather load).

*Note:* The above example is for a spa without an ozone system. If your spa is equipped with an ozone system please contact your dealer for proper Bromine levels.

**Weekly**

1. Twice a week test and adjust Total Alkalinity, pH and Chlorine or Bromine levels.

In extreme cases of source water with high minerals (such as some well water), add 1 tablespoon (14 grams) per 1000 litres (265 gallons) of Arctic Pure® Best Defence weekly.

**Important:** Arctic Pure® Refresh significantly reduces pH and TA. One hour after adding Arctic Pure® Refresh test and adjust TA and pH as needed.

**The use of Clarifiers and Foam inhibitors is not recommended with Silver Sentinel Disposable filters!**

**IMPORTANT: Chemical doses given in this manual are for reference ONLY. ALWAYS refer to product label for instructions.**

## Specifications

### Environmental ratings:

<b>Operating temperature:</b>	32°F (0°C) to 136°F (58°C)
<b>Storage temperature:</b>	-13°F (-25°C) to 185°F (85°C)
<b>Humidity:</b>	Up to 85% RH, non condensing
<b>IPx5 level of waterproofing</b>	

### Mechanical:

#### in.ye

<b>Weight:</b>	Up to 9.7 lbs (4.4 kg)
<b>Dimensions (W x H x D):</b>	19.598" x 10.75" x 4.98" (497 x 273 x 126 mm)

#### in.yt

<b>Weight:</b>	Up to 12 lbs (4.45 kg)
<b>Dimensions (W x H x D):</b>	19.58" x 14.5" x 5.1" (497 x 368 x 130 mm)

### Model Y Series UL/CSA electrical specifications

<b>Input rating:</b>	120/240 V nominal (+5/-10%) (2 lines required with neutral) 48 A Max,
or (in.ye-3 only):	120 V nominal only (+5/-10%) (single line with neutral) 16 A Max, 60 Hz nominal (+1.5 / -1.0 Hz)

#### Heat.wav rating:

<b>Voltage:</b>	120 or 240 V, 60Hz
<b>Wattage:</b>	4 kW at 240 V, 1 kW at 120 V (Also available: 5.5 kW at 240 V)
<b>Flow rate:</b>	Minimum of 18 GPM (68 LPM) is required

UL 1563 Sixth Ed.

UL File: E182156

CSA No. 22.2 - 218.1-M89.



### Model Y Series TUV electrical specifications

<b>Input rating:</b>	230/240 V nominal (+5/-10%) (2-phase system with neutral) 20 A Max per phase, (3-phase system with neutral) 16A Max per phase.
or (in.ye-3 only):	240 V nominal only (+5/-10%) (single-phase system with neutral) 48 A Max, 50 Hz nominal (+1.5 / -1.0 Hz)

#### Heat.wav rating:

<b>Voltage:</b>	240 V, 50Hz
<b>Wattage:</b>	3.8 kW at 230 V 2.8 kW at 230 V
<b>Flow rate:</b>	Minimum of 18 GPM (68 LPM) is required

EN/IEC 60335 - 2 - 60/A2: 2008 - EN/IEC 60335 - 1: 2010

EN55014-1

EN55014-2

EN61000-3-2

EN61000-3-3



## North American Models

Device	Voltage	Maximum current	ye-3*1
Pump 1 (2-spd)	120 or 240 V	15 FLA/60 LRA (inrush)	●
Pump 2 (2-spd)	120 or 240 V	15 FLA/60 LRA (inrush)	●*2
Pump 3 (2-spd)	120 or 240 V	15 FLA/60 LRA (inrush)	
Pump 4 (2-spd)	120 or 240 V	15 FLA/60 LRA (inrush)	
Pump 5 (1-spd)	120 or 240 V	15 FLA/60 LRA (inrush)	
O3/CP	120 or 240 V	6 FLA/10 A	●*3
A1	120 or 240 V	15 FLA/60 LRA (inrush)	
Blower	120 or 240 V	15 FLA/60 LRA (inrush)	
CP	120 or 240 V	6 FLA/10 A	
O3	120 or 240 V	6 FLA/10 A	
Direct out 1	120 or 240 V	10 A (always on)	
Direct out 2	120 or 240 V	10 A (always on)	

\*1 This model can be converted to a dedicated 120 V model.

\*2 Pump #2 can only be installed if Pump #1 is a single-speed pump.

\*3 Total of Pump #1-low (or Pumps #2) and O3/ CP cannot exceed 15 FLA.

\*7 If CP is used, Pump 3 must be 1-speed  
 Total of pump 1-low, O3 and Di1 must not exceed 15 FLA  
 Total of P3, CP, and Di2 must not exceed 15 FLA

\*8 If A1 is used, Pump 4 must be 1-speed  
 Total of O3 and Di1 must not exceed 15 FLA  
 Total of P3, CP, and Di2 must not exceed 15 FLA  
 Total of P5, and B must not exceed 15 FLA  
 Total of P4, and A1 must not exceed 20 FLA



## European Models

Device	Voltage	Maximum current	ye-3*
Pump 1 (2-spd)	230 V	15 FLA/60 LRA (inrush)	●
Pump 2 (2-spd)	230 V	15 FLA/60 LRA (inrush)	●*1
Pump 3 (2-spd)	230 V	15 FLA/60 LRA (inrush)	
Pump 4 (2-spd)	230 V	15 FLA/60 LRA (inrush)	
Pump 5 (1-spd)	230 V	15 FLA/60 LRA (inrush)	
O3/CP	230 V	6 FLA/10 A	●*2
AI	230 V	15 FLA/60 LRA (inrush)	
Blower	230 V	15 FLA/60 LRA (inrush)	
CP	230 V	6 FLA/10 A	
O3	230 V	6 FLA/10 A	
Direct out 1	230 V	10 A (always on)	
Direct out 2	230 V	10 A (always on)	

\*1 Pump #2 can only be installed if Pump #1 is a single-speed pump.

\*2 Total of Pump #1-low (or Pumps #2) and O3/ CP cannot exceed 20 FLA.



### Bear Essential by Arctic Spas Warranty

#### Spa Shell ~ 7 years

Arctic Spas® warrants the spa shell to the customer against water loss due to structural failure for a period of 7 years.

#### Equipment & Plumbing ~ 3 year parts and 1 year labour

Arctic Spas® warrants the spa's electrical equipment components ~ specifically the pump(s) \*(please refer to detailed pump warranty below), factory installed ozone system, heater (including the Tru-Guard™ Heater) and control system against malfunctions due to defects in materials and workmanship for a period of 3 years to the original purchaser from the original date of delivery. Includes parts necessary to repair. Labour is included for a period of 1 year.

#### Other Components ~ 3 years

Arctic Spas® warrants the fuses, lights, jet inserts, topside control overlays, cabinet material, filter baskets and weir assemblies, diverter handles and caps, air control handles and caps, plastic cover clips, chrome trim and all other unmentioned components to be free of defects in workmanship and materials for a period of 3 years to the original purchaser from the original date of delivery. Includes only parts necessary to repair, not labour.

#### Shell Surface ~ 3 years

Arctic Spas® warrants the interior surface to the customer against water loss due to material failure including cracks, blisters, peeling and delaminating for a period of 3 years to the original purchaser from the original date of delivery. Includes parts and labour necessary to repair.

#### Standard Cover ~ 1 year

Arctic spas® warrants the standard Bear Essentials cover against malfunctions due to defects in materials and workmanship for one year to the original owner from the original date of delivery. Includes parts necessary to repair.

#### Upgraded Mylovac Cover ~ 3 years

Arctic Spas® warrants the upgraded MYLOVAC™ cover against malfunctions due to defects in materials and workmanship for three years to the original owner from the original date of delivery. Includes parts necessary to repair. (Normal wear and tear is not included in this warranty, when used with a cover lifter seam damage will be considered normal wear and tear.

#### Essential Sound ~ 1 year

Arctic Spas® warrants the factory installed essential sound stereo system against malfunction due to defects in materials and workmanship for one year to the original customer from original customer from original delivery. Includes parts and onsite labour necessary to repair.

#### Forever Floor ~ 3 years

Arctic Spas® warrants the Forever Floor against rotting and structure cracking for a period of 3 years to the original customer from the original date of delivery. Includes parts and onsite labour necessary to repair.

Arctic Spas® extends this limited warranty solely to the original customer of any Arctic self-contained spa installed by an approved Arctic Spas Dealer, for 3 years of delivery date or 4 years from manufacture ship original purchaser of the spa.



## Bear Essential by Arctic Spas Warranty ( continued )

### DETAILED PUMP WARRANTY

Pump(s) are warranted against material and component failure. The pump shaft seal is covered under warranty. Damage resulting from a neglected leaking shaft seal is not covered under warranty. This includes but is not limited to bearing seizure, end bell failure, start switch failure, impeller failure and capacitor failure. It is the responsibility of the customer to report shaft seal failure before further damage can occur. Any pump component failure determined to be the result of defective material will be replaced under warranty. Arctic Spas® reserves the right to replace pump components, rather than the complete pump assembly. Vibration noise associated with normal pump operation is excluded under this warranty.

### PERFORMANCE

To obtain service in the event of a defect or malfunction covered by this Limited Warranty, notify your Arctic Spa dealer as soon as possible and use all reasonable means to protect the spa from further damage. Upon proof of purchase, Arctic Spas®' agent or its designated service representative will correct the defect subject to the terms and conditions continued in this Limited Warranty. Pre-Approved claims must be executed within 60 days of Pre-approval, All existing claims expire upon expiration of warranty. \*Please note that union connection leaks are considered to be user serviceable and are expressly excluded from the Limited Warranty. Damage resulting from union connection leaks are expressly excluded from the Limited Warranty. There will be no charge for on site labour to the customer for a period of one year from the date of original delivery or 2 years from manufacturer's ship date, whichever comes first. Specifically equipment, plumbing and shell surfaces against malfunctions due to any defect in the material and workmanship within the Limited Warranty. Travel costs are the responsibility of the customer. Your limited warranty will cover a maximum of \$60 towards on site labor per each approved warranty claim. Service and/or travel costs are covered within the first 30 days of ownership to a maximum distance of 100KM from dealership or designated service outlet. If Arctic Spas® determines that repair of the covered defect is not feasible we reserve the right to instead provide a replacement spa equal in value to the original purchase price of the defective spa. Spa replacement is done only at the discretion of Arctic Spas®. Reasonable costs for the removal of the defective spa, and delivery and installation will be the responsibility of the spa customer. Freight will be paid to the nearest Arctic Spas® distribution centre.

### CONDITIONS OF WARRANTIES

All warranties provided hereunder extend only to the original customer of the spa if purchased by an authorized Arctic spas dealer and originally installed within the boundaries of the country where it was originally purchased. All warranties hereunder terminate upon transfer of ownership of a spa from the original customer. This warranty only applies within the service area where the spa was originally installed. Your limited warranty does not include repair travel mileage or for shipping cost assessed by your Factory Authorized Dealer or service agents. All events covered by this Limited Warranty hereunder must be repaired by a Factory Authorized Dealer of Arctic Spas®. The warranties will not include any costs of repair incurred by a non-factory authorized agent. To obtain service, the customer must contact the Factory Authorized Dealer in his area. In the event that a spa or component thereof must be returned to Arctic Spas® distribution centre, all freight costs are the responsibility of the spa customer. In all cases Arctic Spas® has sole responsibility for determining the cause and nature of failure of the spa and Arctic Spas® determination with regard thereto shall be final.

### EXCLUSIONS

All warranties hereunder are void if the spa has been subject to alterations (including after-market accessories), misuse or abuse or any repair of the spa has been attempted by anyone other than a Factory Authorized Dealer of Arctic Spas®. Alterations include but not limited to, any change to the components, replacement of components or addition of components without the written authorization from Arctic Spas®. Misuse includes careless handling of the spa, damages caused by improper and/or non-certified electrical hook-ups, failure to operate the spa in accordance with the instructions contained in the owner's manual provided with the spa, including incorrect start-up procedures or dry firing of the spa, any use of the spa or any of its components in an application for which it was not designed, and damage caused by improper chemical balance (including any damage to spa components caused by scale build up due to poor water chemistry), ice in the spa, overheating the spa or spa water, damage to the spa surface by allowing undissolved sanitizing chemicals to lie on the surface or if our spa has been used for commercial purposes. Spa covers are not warranted against chemical burn or discolouration. Spa covers are not warranted against water absorption or any damage resulting from water absorption. Any damage resulting from the mishandling of the spa cover in any way is not covered under warranty. Any damage caused by moving of the spa or improper installation (including insufficiently prepared or uneven ground) is considered abuse and any damage to the material or workmanship of the spa cabinetry and floor in shipping or handling are expressly excluded from the Limited Warranty.

Arctic Spas will not be responsible for power company issues or improper electrical installations. Damage and/or lack of performance resulting from high or low voltages outside operating parameters. Arctic Spas will not be responsible for software and product upgrades throughout the life of the spa.

Arctic Spas® expressly excludes warranty coverage on any of the following: Acts of nature including but not limited to damage resulting from lightning, storm, flooding, freezing, fire and any other acts of nature. Any spa installed in a commercial application. Any failure caused by improper cover use or or damage to the spa surface by leaving the spa outdoors without the hot tub cover in place. The heat created by leaving the spa in direct UV light without a cover may cause surface issues with the acrylic and may also cause plastic parts to warp, some fittings will leak or cease working as a result. These occurrences are not covered under warranty. The hot tub cover must be kept on the hot tub when not being used.

Scratches or micro-crazing in the spa shell reported after the day of installation are not covered under warranty. Micro-crazing is defined as an area of tiny shiny lines visible in areas on the surface of some thermoplastic sheets. This phenomena, although rare, is known to occur in many types of plastic sheet materials. The surfaces of thermoformed acrylic hot tubs are not immune to this possibility.

Damaged caused by unapproved sanitizers such as tri-chlor, acids, calcium hypochlorite, sodium hypochlorite, peroxides, any sanitizing chemical that may remain undissolved on the spa surface. **Any and all sanitation systems or chemicals used in your spa must be factory approved by Arctic Spas or your warranty is void.** You can check for a list of approved systems and chemicals at arcticspas.com. Installation of not factory approved salt systems will void the warranty related to pump seals, metal part, jets, etc. Damage caused by any item(s) attached to or installed onto the spa, including but not limited to gazebos, cover lifters and cedar accessories. Any options or additional components that are not factory installed are not covered under warranty. Any damage or failure due to improper preparation for winter storage is not covered under warranty. Damage to pillows reported beyond the day of delivery will not be covered under warranty. Pillows are to be removed from the spa when not in use. Any damage resulting from the use of cover removing mechanisms is not covered under warranty.

### DISCLAIMERS

Arctic Spas® will not be liable for loss of use of the spa or other incidental or consequential costs, expenses or damages that may include but not limited to, the removal of a permanent sun deck, sunroom, gazebo, or other custom fixture, any crane costs associated with the removal of the spa for service or replacement. Arctic Spas® shall not be liable for costs arising from water, filter cartridges and chemical loss. Under no circumstances shall Arctic Spas® or any of its representatives be liable for any injury to any person or damage to any property, howsoever arising from the spa. Arctic Spas® warranties are limited to a maximum amount of moneys received by Arctic Spas® with respect to the sale of the spa.

### ALL WARRANTIES

The warranties contained herein are all of the warranties provided by Arctic Spas® to the customer, and to the extent permitted by law. Warranty registration (within 30 days of delivery) is the responsibility of the customer and is a condition of warranty coverage. This Warranty is offered as an extra benefit and does not affect your statutory rights. All warranties herein require that any claim must be submitted to Arctic Spas® within ten days of the time the defect is discovered, and must be accompanied by the original customer's receipt confirming purchase of the spa, which shows the date of purchase. All warranty claims must be submitted within the warranty period. Failure to provide such notice and information invalidates all warranties provided hereunder. Arctic Spas® reserves the right to repair or replace components or materials at its option. In certain cases, photographs may be required for proper evaluation before warranty coverage is determined. In the event a customer is unable to either obtain parts or satisfactory service from a Factory Authorized Dealer of Arctic Spas®, notice should be given immediately to the service department of the agent where the spa was purchased and to Arctic Spas®.

Arctic Spas® expressly excludes warranty coverage on splitting, fading or warping of the cedar cabinet beyond the date of delivery. Any damage resulting from handling of the cedar cabinet is excluded from this warranty. This warranty will not cover any labour for Bluetooth connection assistance/issues, onSpa® App initialization & connection assistance/issues from a smartphone, or assistance with actually connecting any of these devices.





engineered for the world's harshest climates®...  
(wherever you happen to live)

#17908